

TCL

S55H

무선 서브우퍼가 탑재된 2.1 채널 Dolby Atmos 사운드바
퀵 스타트 가이드



1



이 제품을 사용하기 전에 모든 안전 정보를
읽으십시오.

- * HDMI 케이블/광케이블을 일부
지역에서는 사용할 수 없습니다.
- * 전원 플러그 디자인은 다를 수 있습니다.

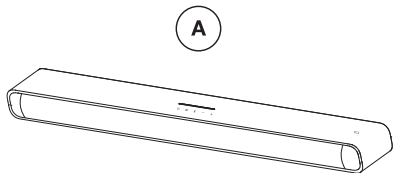

C x 2



D



E



F x 2



G x 2



H x 2



I x 2



J



K



L



M

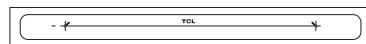

2a

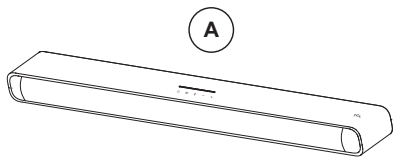

- ① AC 입력 전원 커넥터
- ② AUX 입력 커넥터
- ③ HDMI eARC 커넥터
- ④ 옵티컬 입력 커넥터
- ⑤ USB Type A 커넥터

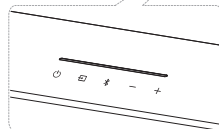
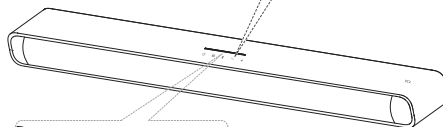
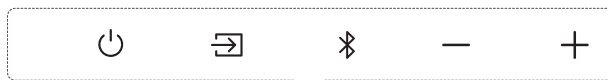
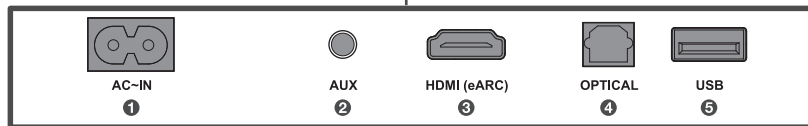
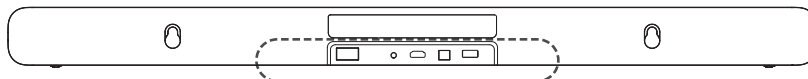

2b



B

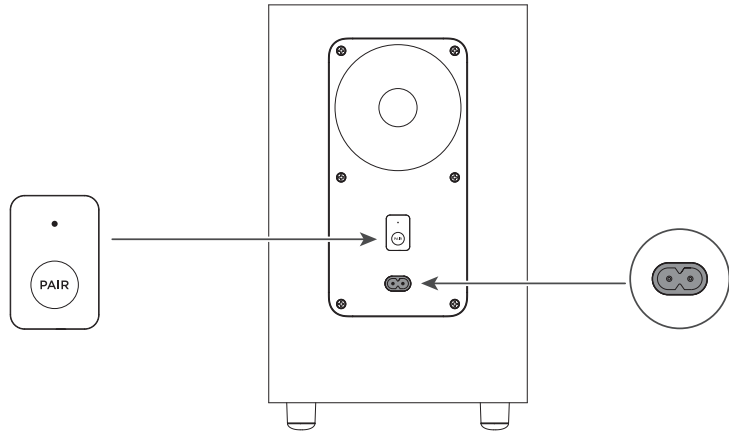
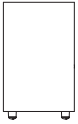

2c



A

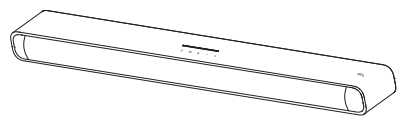

B

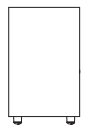

1

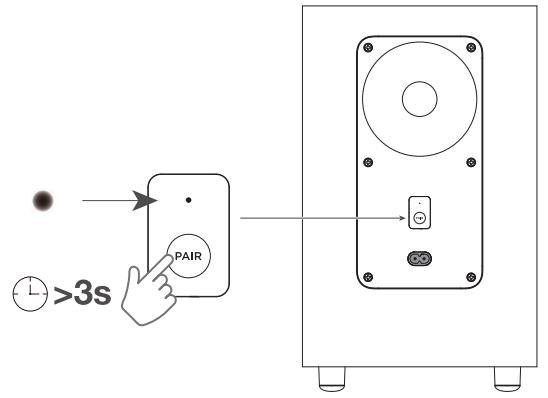

2

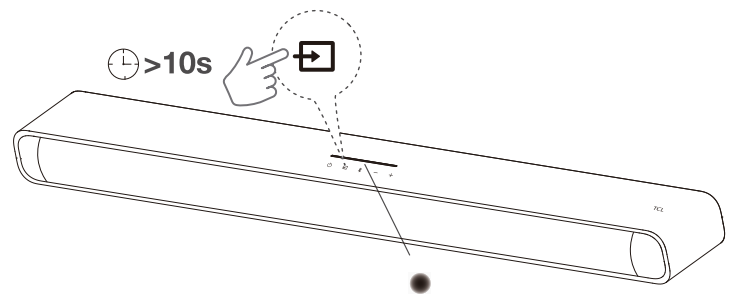

3a



사운드바를 배치하기에 이상적인 위치는 텔레비전 아래 중심에 위치시키는 것입니다.

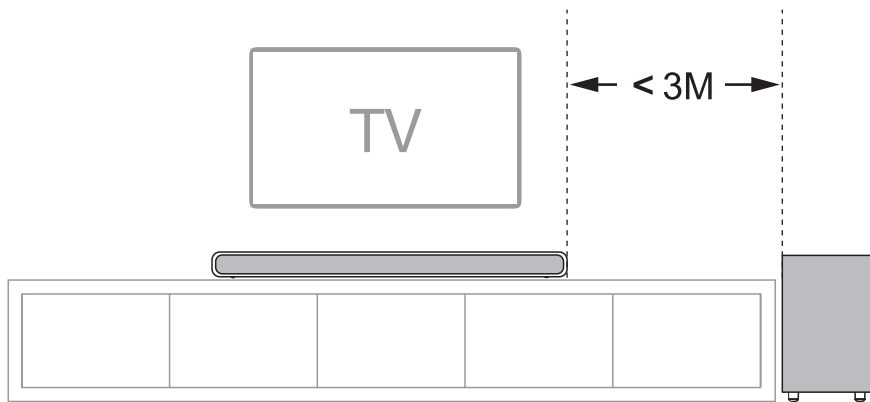

3b



M

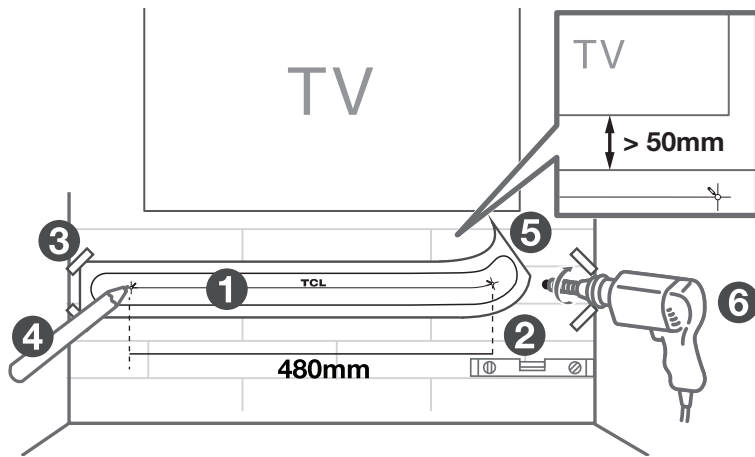
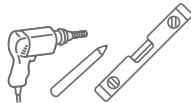
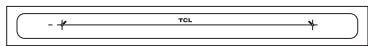

3c



G x 2



H x 2



I x 2

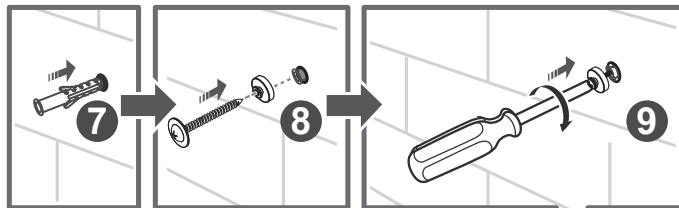

10

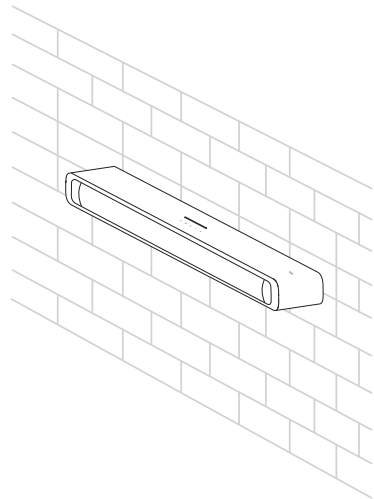
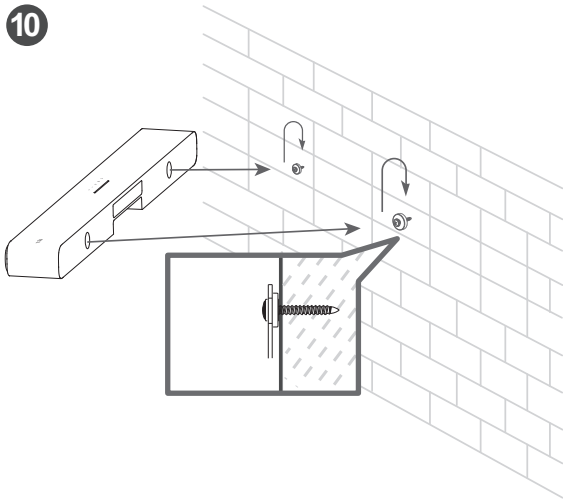



배터리 유형: 1.5V AAA 배터리 x 2

E



F x 2



경고: 배터리를 햇빛, 불 등과 같은 과도한 열에 노출시키지 마십시오. 새로운 및 사용된 배터리를 어린이에게서 멀리 보관하십시오. 폐기 또는 재활용 정보에 대해 현지 주관부서에게 문의하십시오.

주의: 배터리를 잘못 교체하면 폭발할 위험이 있습니다. 동일하거나 동등한 유형으로만 교체하십시오.

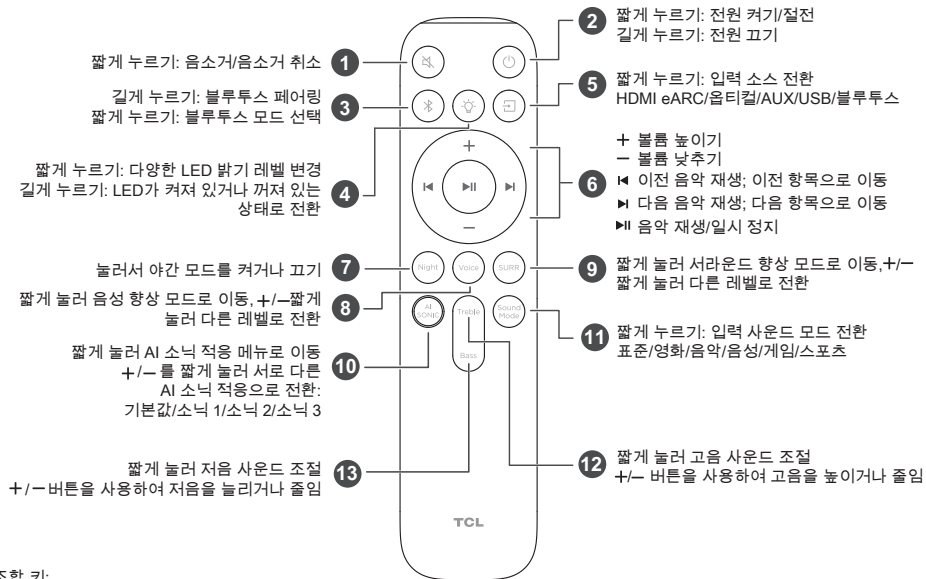
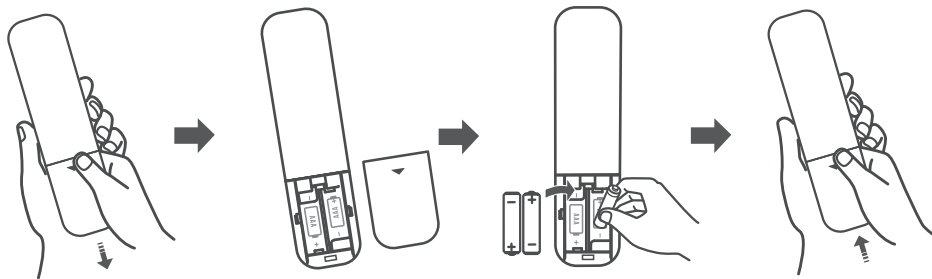

조합 키:

1. E 및 F 눌러 DTS TruVolume을 활성화하거나 비활성화하십시오.
2. E 및 F 눌러 DTS® Virtual:X™를 활성화하거나 비활성화하십시오.

5

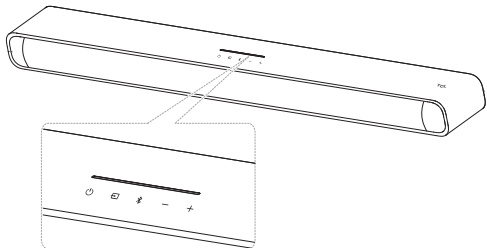

LED 상태는 사운드바 작동 상황을 파악하는 데 도움이 됩니다.

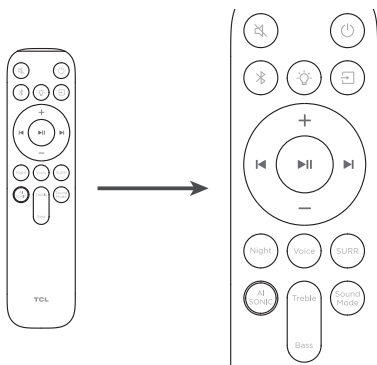

| 리모컨 | 사운드바 작동 | 사운드바의 LED 작동 |
|-----|-------------------|-------------------------------------------------------------------------------------|
| | 전원 끄기/절전 전원 켜기 | 전원 끄기: 모든 LED 조명이 양쪽에서 중심으로 꺼지고 꺼집니다. 전원 켜기: LED가 중심에서 양쪽으로 켜집니다. |
| | 음소거 | 음소거 켜기: 중심 LED가 몇 번 깜박입니다. 음소거 끄기: 현재 볼륨이 표시됩니다. |
| | 소스 | 입력 소스 LED 표시등: HDMI eARC: 자홍색 옵티컬: 노란색 Aux: 녹색 USB: 청록색 블루투스: 파란색 |
| | LED | 짧게 누르기: LED의 밝기 레벨을 변화시킵니다. 길게 누르기: LED가 켜져 있거나 꺼져 있는 상태로 전환합니다. |
| | 블루투스 페어링 | 파란색 LED가 빠르게 깜박입니다. |
| | 볼륨 높이기/낮추기 | 볼륨 높이기: LED는 중심에서 양쪽으로 점진적으로 켜집니다. 볼륨 낮추기: LED가 양쪽에서 중심으로 점진적으로 꺼집니다. |
| | 건너뛰기/이전 | 건너뛰기: LED가 왼쪽에서 오른쪽으로 움직입니다. 이전: LED가 오른쪽에서 왼쪽으로 움직입니다. |
| | 서라운드 향상 | 네 가지 다른 서라운드 사운드 레벨을 조절하려면 누르십시오. |
| | 음성 향상 | 짧게 누르기: 현재 음성 향상 레벨을 미리 설정합니다. +/- 키를 사용하여 네 가지 다른 레벨을 조절하십시오. |
| | 야간 모드 | 야간 모드 켜기: LED가 중심에서 양쪽으로 켜집니다. 야간 모드 끄기: 모든 LED 조명이 양쪽에서 중심으로 켜지고 꺼집니다. |
| | 사운드 모드 | 다음 순서로 사운드 모드를 전환합니다. 표준/영화/음악/음성/게임/스포츠 |
| | 고음 조절 | 짧게 누르기: 현재 고음 레벨을 표시합니다. +/- 키를 사용하여 열세 개의 다른 레벨을 조절하십시오. |
| | 저음 조절 | 짧게 누르기: 현재 저음 레벨을 표시합니다. +/- 키를 사용하여 열세 개의 다른 레벨을 조절하십시오. |
| | 소닉 기본값1/2/3 | 짧게 눌러서 AI 소닉 적응 메뉴로 이동 +/- 를 짧게 눌러 서로 다른 AI 소닉 적응으로 전환: 기본값/소닉 1/소닉 2/소닉 3 |

6a



다음 두 가지 방법으로 사운드바를 텔레비전에 연결할 수 있습니다(권장 순서로 나열). HDMI eARC(6a 참조) 및 옵티컬(6b 참조)

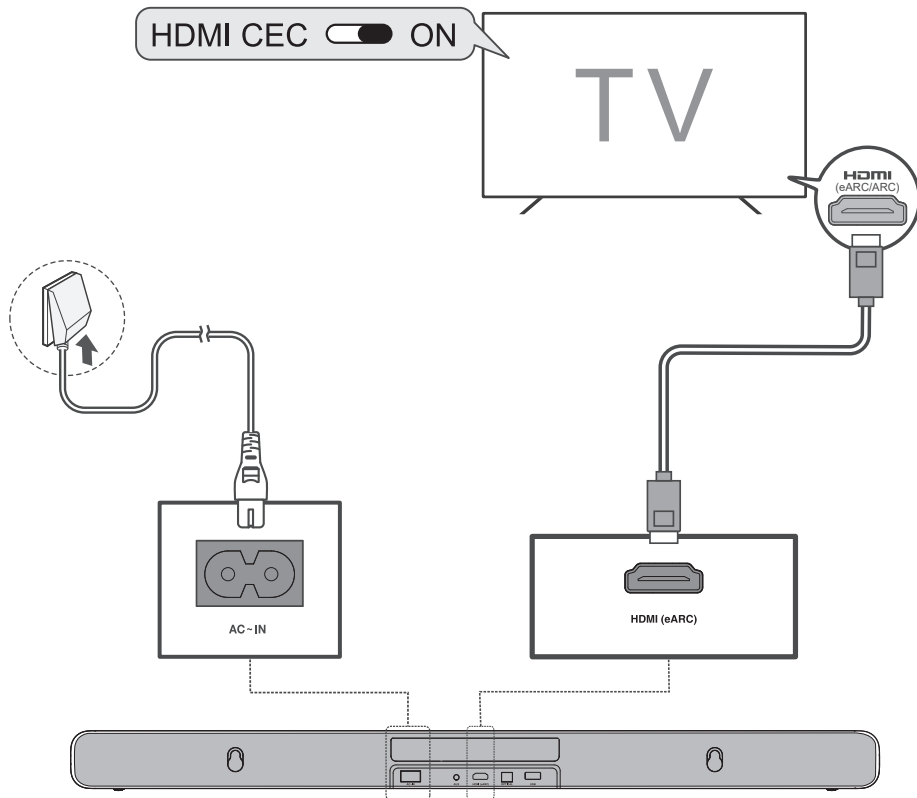

6a



HDMI 케이블을 통해 사운드바를 텔레비전과 연결합니다.

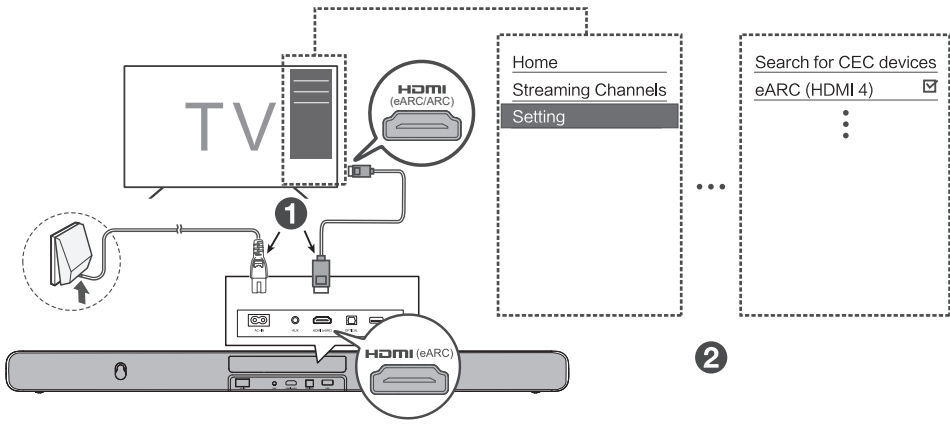
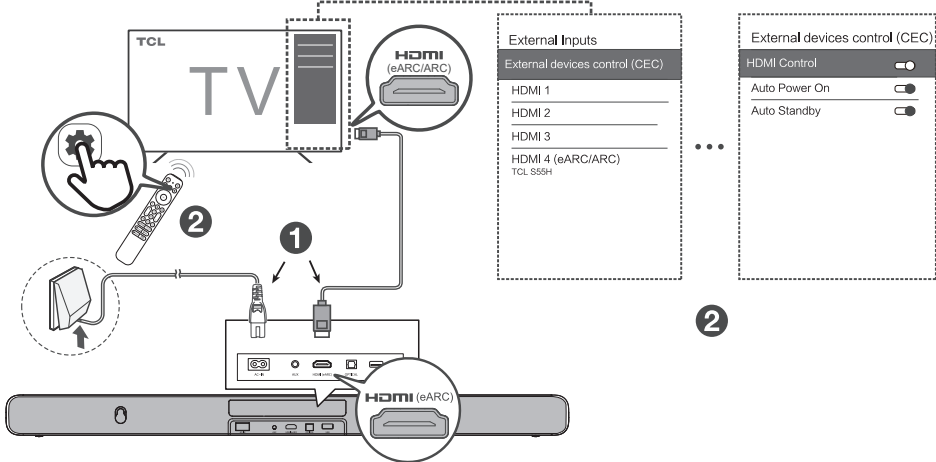

6b



광케이블(제공되지 않음)을 통해
사운드바를 텔레비전에 연결합니다.

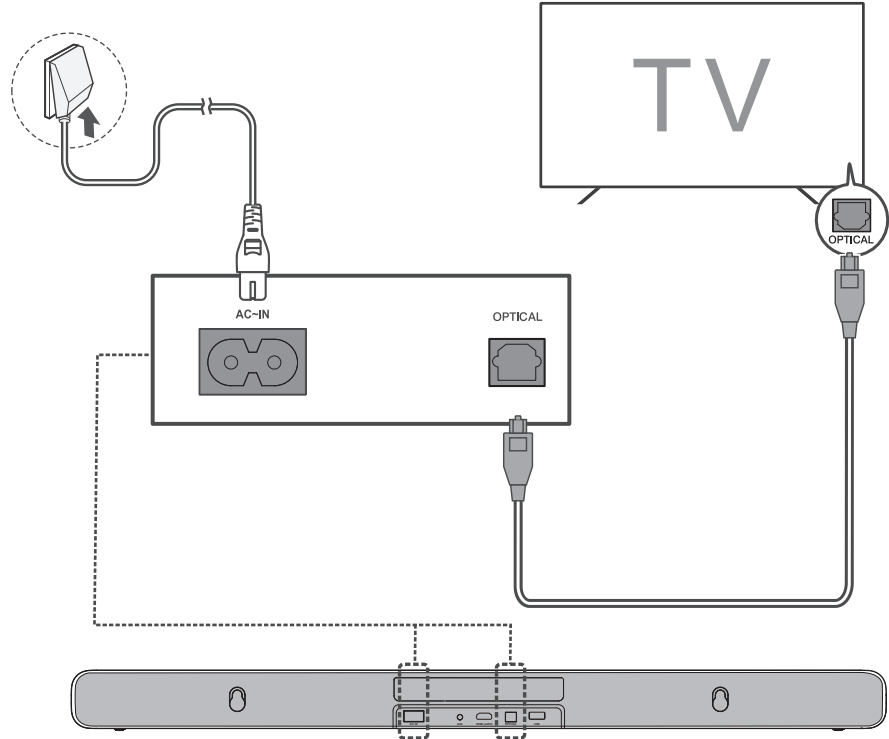

7



장치에서 TCL S55H를 선택합니다

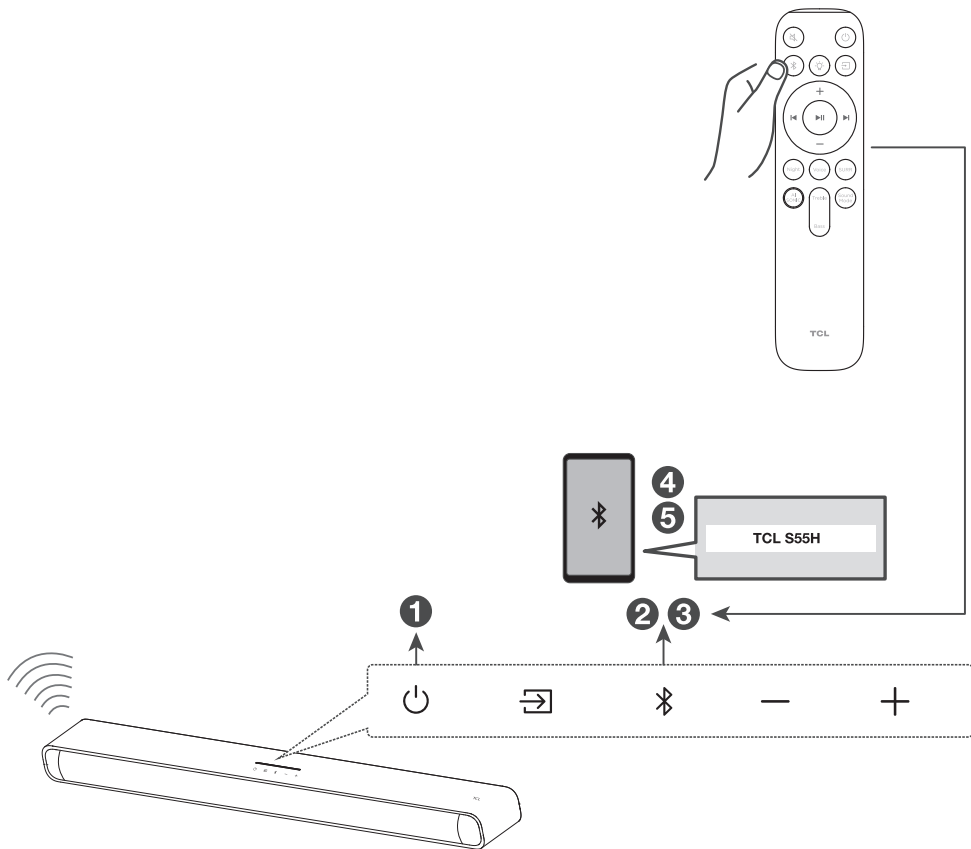



지원되는 오디오 파일: MP3, WMA, FLAC, WAV.

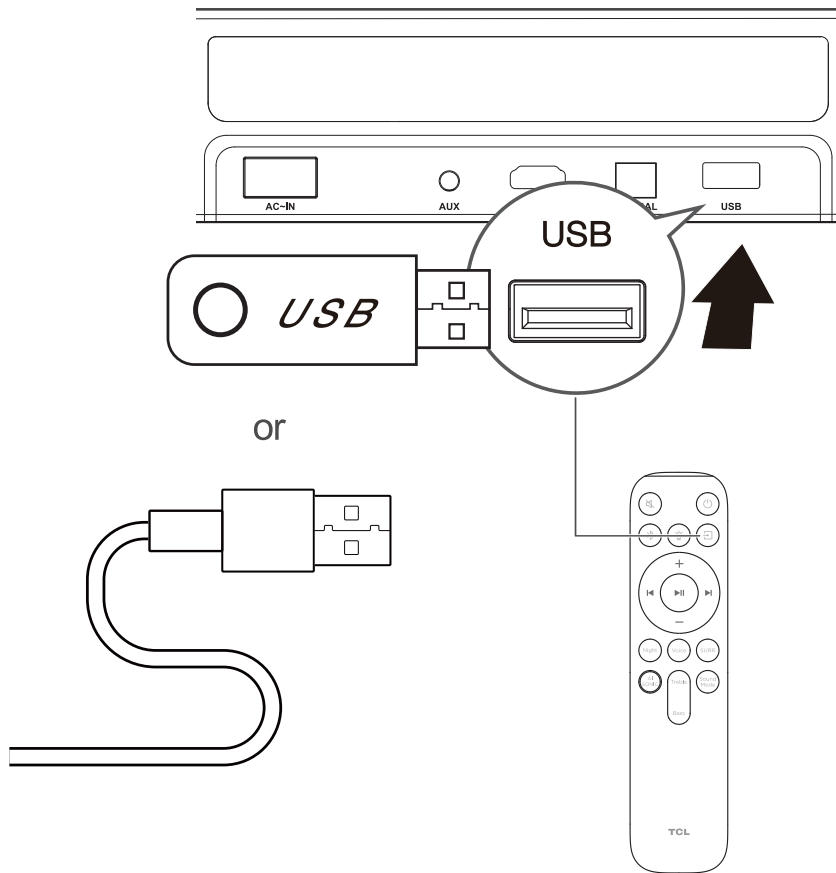



또는



이 케이블은 별도로 판매합니다.

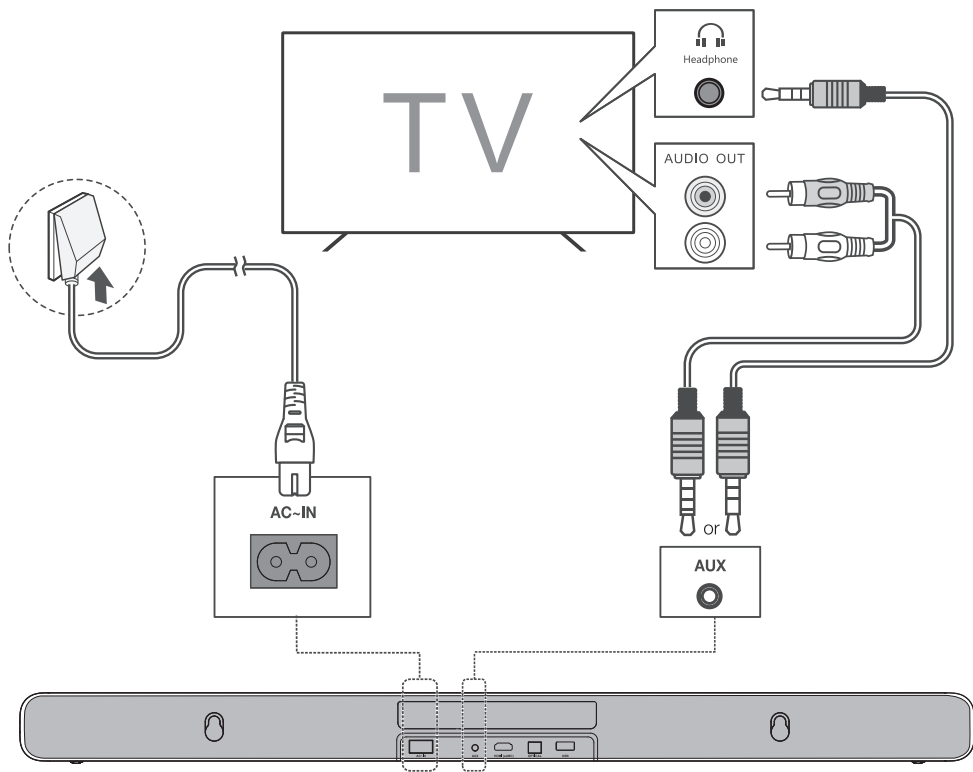

Settings → Display & Sound → Audio Output →
Internal Speaker+Soundbar(HDMI)

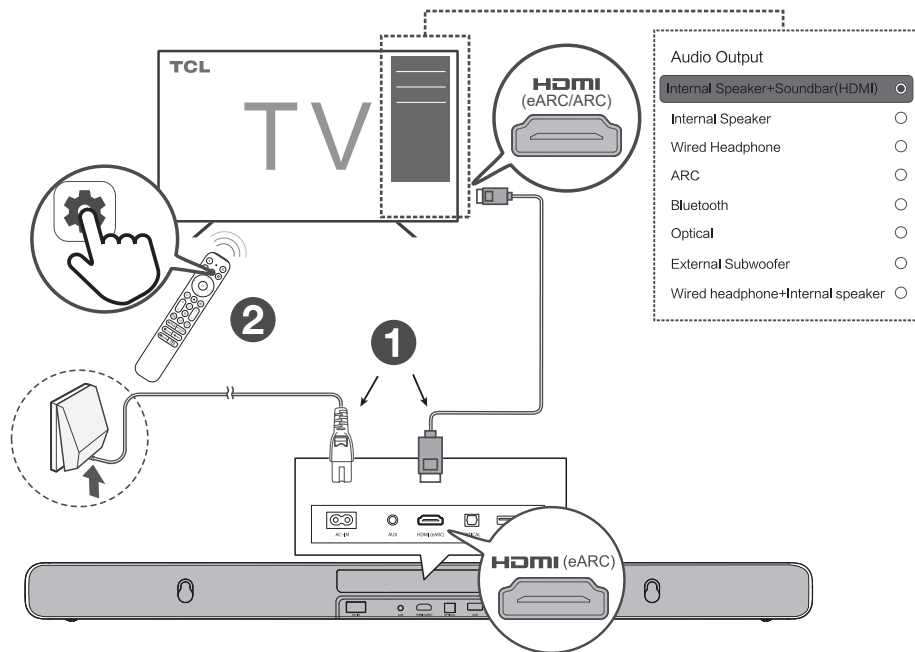

11



TCL
HOME



TCL 홈 앱
당신의 TCL
스마트 허브.
지금 다운로드!

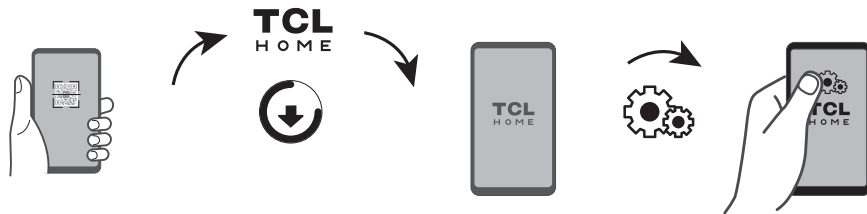

12



AI 소닉 적응

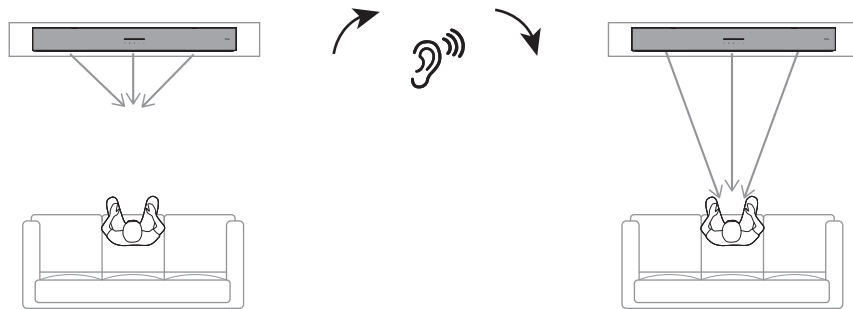

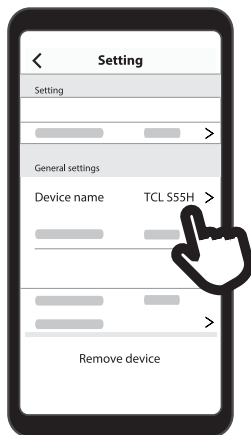

1

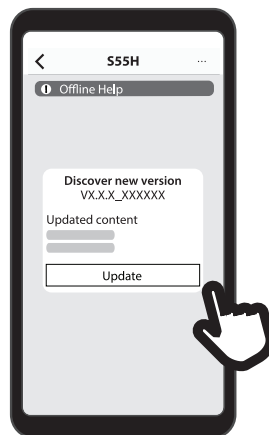

2

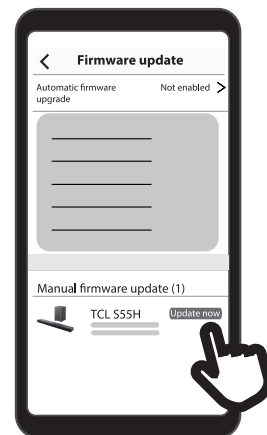

3

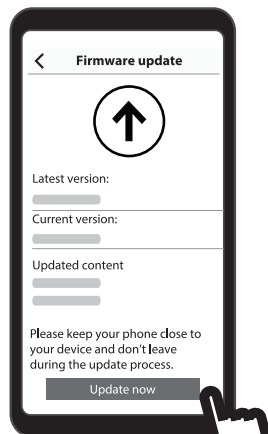

4

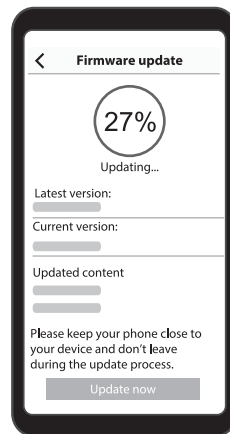

5

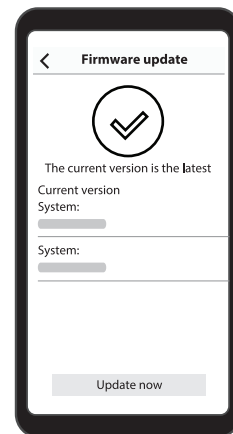

상표

Dolby Atmos

Dolby, Dolby Atmos, and the double-D symbol are registered trademarks of Dolby Laboratories Licensing Corporation. Manufactured under license from Dolby Laboratories. Confidential unpublished works. Copyright © 2012-2024 Dolby Laboratories. All rights reserved.

Bluetooth®

Bluetooth® 문자 로고 및 로고는 Bluetooth SIG, Inc. 소유한 등록 상표이고, TTE Corporation은 그러한 마크에 대한 어떠한 사용도 허가를 받은 것입니다. 다른 상표 및 상호명은 해당 소유자의 상표와 상호명입니다.

dts®

DTS 특허에 대해서는 <http://patents.dts.com> 을 참조하세요. DTS, Inc.의 허가를 받아 제작되었습니다. DTS, Digital Surround, Virtual:X 및 DTS 로고는 미국 및 기타 국가에서 DTS, Inc.의 등록 상표 또는 상표입니다.

© 2024 DTS, Inc. 판권 소유.

HDMI™ HIGH-DEFINITION MULTIMEDIA INTERFACE

HDMI, HDMI High-Definition Multimedia Interface(고화질 멀티미디어 인터페이스), HDMI 트레이드 드레스 및 HDMI 로고라는 용어는 HDMI Licensing Administrator, Inc.의 상표 또는 등록 상표입니다.

스토어에 반품하지 마십시오

저희는 항상 도움을
제공해 드리는 준비가
되어 있습니다

질문이 있으시면
먼저 저희에게
연락해 주십시오



TCL 지원:
www.tcl.com



사운드바를 분리할 때
조심하십시오

인증 받은 자의 상호: TCL OVERSEAS MARKETING LTD
기의 명칭: 무선 서브우퍼가 탑재된 2.1 채널 Dolby Atmos 사운드바, S55H
기의 명칭: 무선 서브우퍼, S55H-SW

Copyright © 2024 TCL.
All rights reserved.

S55H-GL-KR_QSG_V0.4