

# TCL

## Q75H

5.1.2 Channel Dolby Atmos Soundbar with Wireless Subwoofer

回音壁聲學系統

(5.1.2聲道杜比全景聲無線重低音揚聲器)

Quick Start Guide

快速設定指南



English | French | Spanish | Portuguese | Arabic | Japanese | Korean | 中文(繁體) |  
Vietnamese | Indonesian | Thai



**EN** Make sure you read all the safety information before you use this product.

- ★ HDMI cable/Optical cable are not available in some locations.
- ★ Power plug design may vary.

**FR** Assurez-vous d'avoir lu toutes les informations relatives à la sécurité avant d'utiliser cet appareil.

- ★ Le câble HDMI / câble optique ne sont pas disponibles dans certains endroits.
- ★ La conception de la prise d'alimentation peut varier.

**ES** Asegúrese de leer toda la información de seguridad antes de usar este producto.

- ★ El cable HDMI / cable óptico no están disponibles en algunos lugares.
- ★ El diseño del enchufe de alimentación puede variarse.

**PT** Leia todas as informações de segurança antes de usar o produto.

- ★ O cabo HDMI/cabo ótico não estão disponíveis em alguns locais.
- ★ O projeto da tomada pode variar.

**AR** تأكد من قراءة جميع معلومات السلامة قبل استخدام المنتج.  
 ★ لا يتوفر كابل HDMI /الكابلات البصرية بعض المواقع  
 ★ تصميم قابس الطاقة يكون مختلفا

**JP** この製品を使用する前に、すべての安全情報を必ずお読みください。

- ★ HDMIケーブル/光デジタルケーブルは、地域によって使用できない場合があります。
- ★ 電源プラグのデザインは異なる場合があります。

**KR** 이 제품을 사용하기 전에 모든 안전 정보를 읽으십시오.

- ★ HDMI 케이블/광케이블을 일부 지역에서는 사용할 수 없습니다.
- ★ 전원 플러그 디자인은 다를 수 있습니다.

**CN** 使用此產品前，請務必閱讀所有安全資料。

- ★ 有些地區不支援HDMI/光纖。
- ★ 電源插頭設計可能有所不同。

**VN** Hãy chắc chắn rằng bạn đọc tất cả thông tin an toàn trước khi sử dụng sản phẩm này.

- ★ Cáp HDMI/Cáp quang không có sẵn ở một số địa điểm.
- ★ Thiết kế phích cắm điện có thể khác nhau.

**ID** Pastikan Anda membaca semua informasi keselamatan sebelum menggunakan produk ini.

- ★ Kabel HDMI/Kabel optik tidak tersedia di beberapa lokasi.
- ★ Desain steker listrik mungkin berbeda-beda.

**TH** ตรวจสอบใบแจ้งความปลอดภัยก่อนใช้งานก่อนที่จะใช้ผลิตภัณฑ์

- ★ สาย HDMI/สาย Optical ไม่พร้อมใช้งานในบางพื้นที่
- ★ การออกแบบปลั๊กไฟอาจแตกต่างกันไป

A

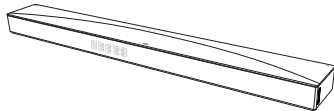

**Soundbar**  
揚聲器主機

B

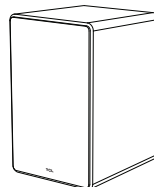

**Subwoofer**  
無線重低音揚聲器

C x 2



**AC Power cord x 2**  
交流電源線 x 2

D



**HDMI cable**  
HDMI 纜線

E



**Remote Control**  
遙控器

F

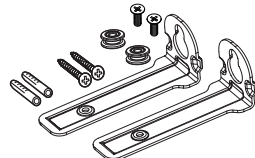

**Wall Mount Kit**  
(for Soundbar)  
壁掛式工具包  
(用於條形聲霸)

G



**Quick Start Guide**  
快速設定指南

H



**Safety leaflet**  
安全手冊

I

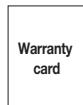

**Warranty card**  
保證書

J

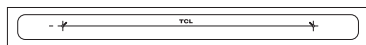

**Wall mount template**  
壁掛式模板

# 2a



A

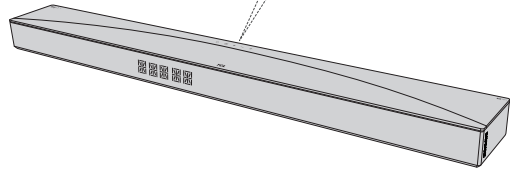
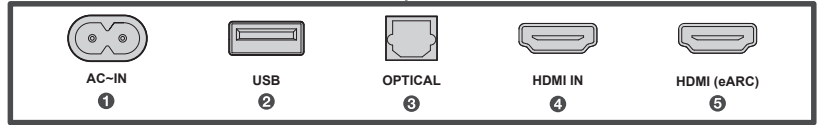
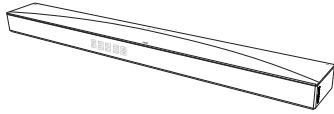

2b



B

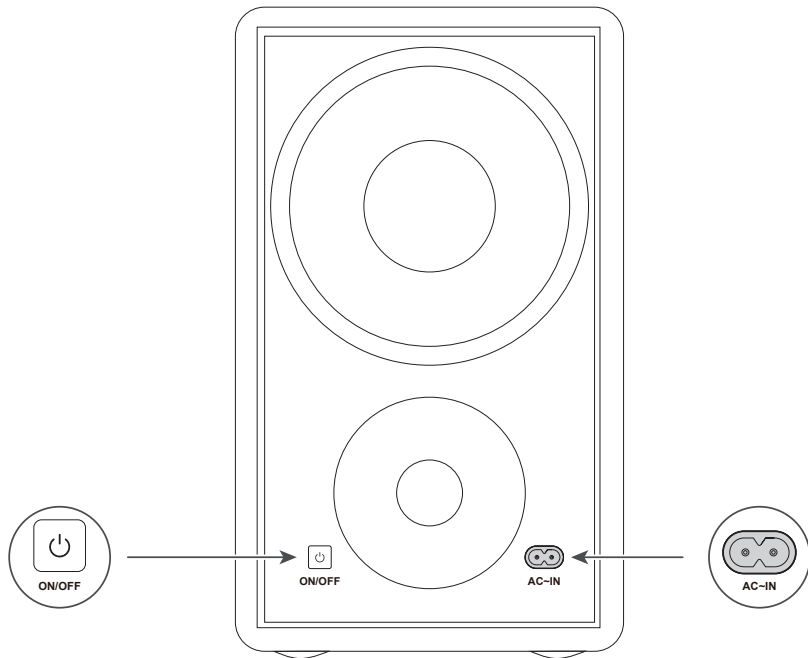
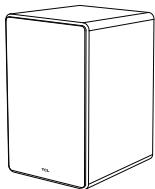

2c



A

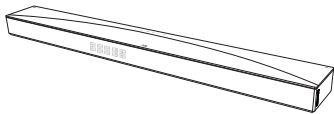

B

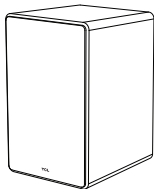

1

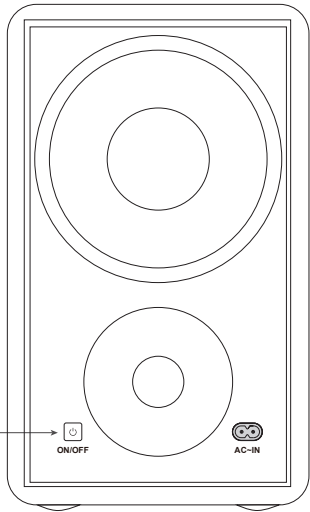

2

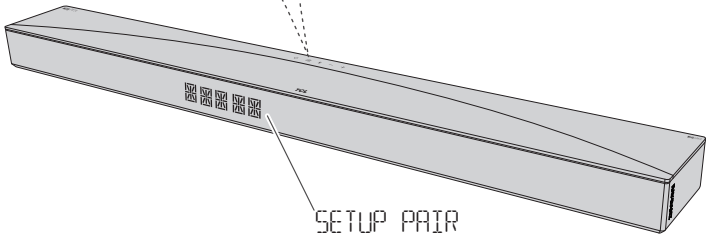



The Soundbar LED display indicates various Soundbar functions.

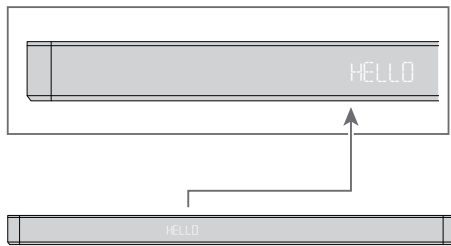

**Note:**

- **Factory Reset:** Long Press three keys  $\odot$ ,  $+$  and  $-$  on the Soundbar panel together for 10s simultaneously till the LED display shows "FACTORY RESET" and then power cycle automatically.

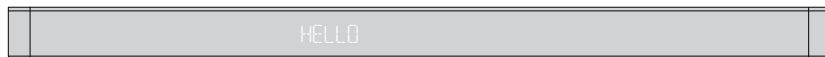



	Soundbar Status	LED Display Status
<b>Power</b>	Power on Power off	HELLO STDBY / SLEEP
<b>Source</b>	HDMI eARC/ARC Optical USB Bluetooth HDMI IN	HDMI EARC OPT USB BT HDMI IN
<b>Bluetooth</b>	Searching mode (flashing) Pairing mode	BT PAIRING
<b>Volume control</b>	Volume level Minimum volume reached Maximum volume reached Mute	V 36 MIN MAX MUTE
<b>Audio setting</b>	Bass (+/-) Treble (+/-) Voice Enhance Surround Enhance AI SONIC  Pass Through Night	BAS LOW / BAS MEDIUM / BAS HIGH TRE LOW / TRE MEDIUM / TRE HIGH VOICE ON / VOICE OFF Surr ON / Surr OFF POSITION 1 / POSITION 2 / POSITION 3 / OFF  PASS THROUGH / -X- & PASS THROUGH NIGHT ON / NIGHT OFF
<b>Sound modes</b>	Standard/Movie/Music/ Voice/Game/Sports	STANDARD MOVIE MUSIC VOICE GAME SPORTS
<b>Light</b>	Light Setting	LIGHT 1 / LIGHT 2 / LIGHT 3

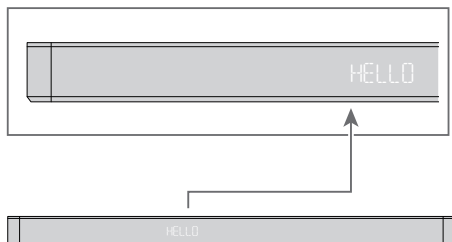

L'écran LED de la barre de son indique les différentes fonctions de la barre de son.



#### Remarque :

- **Réinitialisation d'usine :** Appuyez longuement sur les trois touches ,  et  du panneau de la barre de son pendant 10 secondes simultanément jusqu'à ce que l'écran LED affiche « FACTORY RESET », puis l'appareil s'éteint automatiquement.

	État de la barre de son	État d'affichage LED
<b>Alimentation</b>	Mise sous tension Mise hors tension	HELLO STDBY / SLEEP
<b>Source</b>	HDMI eARC/ARC Optique USB Bluetooth ENTRÉE HDMI	HDMI EARC OPT USB BT HDMI IN
<b>Bluetooth</b>	Mode de recherche (clignotant) Mode d'appairage	BT PAIRING
<b>Contrôle du volume</b>	Niveau de volume Volume minimal atteint Volume maximal atteint Muet	V 36 MIN MAX MUTE
<b>Réglage audio</b>	Basses (+/-) Aigus (+/-) Amélioration Voix Amélioration Ambiophonie SONIQUE AI	BAS LOW / BAS MEDIUM / BAS HIGH TRE LOW / TRE MEDIUM / TRE HIGH VOICE ON / VOICE OFF SURR ON / SURR OFF POSITION 1 / POSITION 2 / POSITION 3 / OFF
	Passer Nuit	PASS THROUGH / -X- & PASS THROUGH NIGHT ON / NIGHT OFF
<b>Modes sonores</b>	Standard/Film/Musique/ Voix/Jeu/Sport	STANDARD MOVIE MUSIC VOICE GAME SPORTS
<b>Voyant</b>	Réglage du voyant	LIGHT 1 / LIGHT 2 / LIGHT 3



La pantalla LED de la Barra de Sonido muestra varias funciones de la misma.

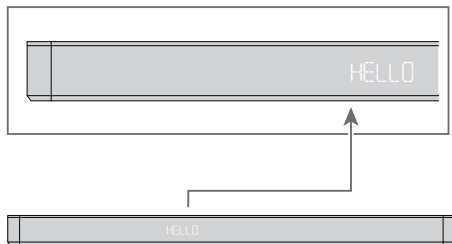

#### Nota:

- **Restablecimiento de Fábrica:** Mantenga presionadas simultáneamente las tres teclas **⏻**, **+** y **-** en el panel de la barra de sonido durante 10 segundos hasta que la pantalla LED muestre "RESTABLECIMIENTO DE FÁBRICA" y luego se apague y encienda automáticamente.

	Estado de Barra de Sonido	Estado de Pantalla LED
<b>Potencia</b>	<b>Encendido</b> <b>Apagado</b>	HELLO STDBY / SLEEP
<b>Fuente</b>	<b>HDMI eARC/ARC</b> <b>Óptica</b> <b>USB</b> <b>Bluetooth</b> <b>HDMI IN</b>	HDMI eARC OPT USB BT HDMI IN
<b>Bluetooth</b>	<b>Modo de búsqueda (parpadeante)</b> <b>Modo de emparejamiento</b>	BT PAIRING
<b>Control del volumen</b>	<b>Nivel de volumen</b> <b>Volumen mínimo alcanzado</b> <b>Volumen máximo alcanzado</b> <b>Silencio</b>	V 36 MIN MAX MUTE
<b>Ajuste de Audio</b>	<b>Graves (+/-)</b> <b>Agudos (+/-)</b> <b>Mejora de Voz</b> <b>Mejora de Sonido Envolverte</b> <b>AI SONIC</b>  <b>Pass Through</b> <b>Nocturno</b>	DBS LOW / DBS MEDIUM / DBS HIGH TRE LOW / TRE MEDIUM / TRE HIGH VOICE ON / VOICE OFF SURR ON / SURR OFF POSITION 1 / POSITION 2 / POSITION 3 / OFF  PASS THROUGH / -X- & PASS THROUGH NIGHT ON / NIGHT OFF
<b>Modos de sonido</b>	<b>Estándar/Películas/Música/ Voz/Juegos/Deportes</b>	STANDARD MOVIE MUSIC VOICE GAME SPORTS
<b>Luz</b>	<b>Ajuste de luz</b>	LIGHT 1 / LIGHT 2 / LIGHT 3



A tela LED da Barra de Som indica vários Funções da Barra de Som.

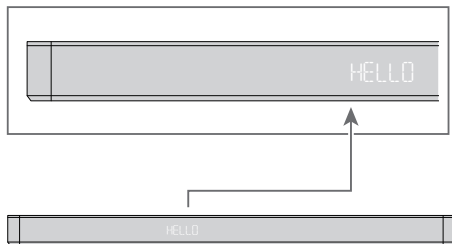

#### Observação:

- **Redefinição de fábrica:** pressione longamente três botões  $\cup$ ,  $\oplus$  e  $\ominus$  no painel do alto-falante de barra juntos por 10s simultaneamente até que o display LED mostre "REDEFINIÇÃO DE FÁBRICA" e, em seguida, desligue e ligue automaticamente.

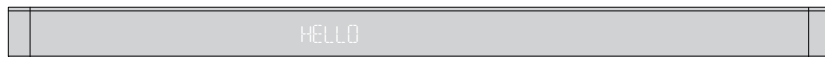

	Estado da Barra de Som	Estado da Tela LED
<b>Energia</b>	Ligar Desligar	HELLO STDBY / SLEEP
<b>Fonte</b>	HDMI eARC/ARC Ótica USB Bluetooth HDMI IN	HDMI eARC OPT USB BT HDMI IN
<b>Bluetooth</b>	Modo Searching (Pesquisa) (intermitente) Modo Pairing (Emparelhamento)	BT PAIRING
<b>Controle do volume</b>	Nível do volume Volume mínimo atingido Volume máximo atingido Mudo	V 36 MIN MAX MUTE
<b>Configuração de áudio</b>	Graves (+/-) Agudos (+/-) Aprimoramento de Voz Aprimoramento do Surround AI SONIC	BAS LOW / BAS MEDIUM / BAS HIGH TRE LOW / TRE MEDIUM / TRE HIGH VOICE ON / VOICE OFF SURR ON / SURR OFF POSITION 1 / POSITION 2 / POSITION 3 / OFF
	Modo de permeabilidade Noite	PASS THROUGH / -X- & PASS THROUGH NIGHT ON / NIGHT OFF
<b>Modos de som</b>	Padrão/Filme/Música/ Voz/Jogos/Espportes	STANDARD MOVIE MUSIC VOICE GAME SPORTS
<b>Luz</b>	Configuração de luz	LIGHT 1 / LIGHT 2 / LIGHT 3



تشير شاشة LED Soundbar إلى وظائف مختلفة لـ Soundbar.

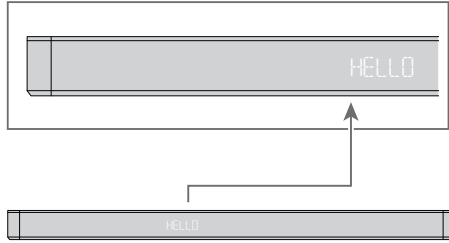

#### ملحوظة:

- إعادة ضبط المصنع: اضغط لفترة طويلة على ثلاثة أزرار  $\odot$  و  $+$  و  $-$  على LED لوحة مكبر الصوت معاً لمدة 10 ثوانٍ في وقت واحد حتى تعرض شاشة إعادة ضبط المصنع " ثم دورة الطاقة تلقائياً"

حالة عرض LED	حالة Soundbar	
HELLO STDBY / SLEEP	تشغيل إيقاف التشغيل	الطاقة
HDMI eARC OPT USB BT HDMI IN	<b>HDMI eARC/ARC</b> بصري <b>USB</b> <b>Bluetooth</b> <b>HDMI IN</b>	مصدر
BT PAIRING	وضع البحث (وامض) وضع الإقتران	<b>Bluetooth</b>
V 36 MIN MAX MUTE	مستوى الصوت تم الوصول إلى الحد الأدنى للحجم تم الوصول إلى الحد الأقصى للحجم صامت	التحكم في حجم الصوت
BAS LOW / BAS MEDIUM / BAS HIGH TRE LOW / TRE MEDIUM / TRE HIGH VOICE ON / VOICE OFF SURR ON / SURR OFF POSITION 1 / POSITION 2 / POSITION 3 / OFF PASS THROUGH / -X- & PASS THROUGH NIGHT ON / NIGHT OFF	بيس (+/-) صوت مرتفع (+/-) تحسين الصوت التحسين المحيطي <b>AI SONIC</b> وضع الصوت المحيط ليلة	إعدادات الصوت
STANDARD MOVIE MUSIC VOICE GAME SPORTS	قياسي/فيلم/موسيقى/صوت/ لعبة/رياضة	أوضاع الصوت
LIGHT 1 / LIGHT 2 / LIGHT 3	إعدادات الضوء	ضوء



サウンドバーのLEDディスプレイには、サウンドバーのさまざまな機能が表示されます。

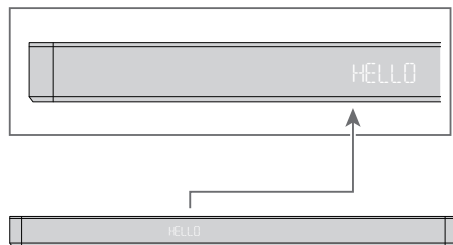

#### 注意：

- **初期化**：サウンドバーのパネル上の **0**、**+**、**-**の3つのキーを同時に10秒間長押しして、LEDディスプレイに「初期化」が表示されるまで押し続け、その後電源が自動的に再起動します。

	サウンドバーステータス	LEDディスプレイステータス
<b>電源</b>	電源オン 電源オフ	HELLO STDBY / SLEEP
<b>ソース</b>	HDMI eARC/ARC 光学 USB Bluetooth HDMI入力	HDMI EARC OPT USB BT HDMI IN
<b>Bluetooth</b>	検索モード (点滅) ペアリングモード	BT PAIRING
<b>音量制御</b>	音量 最小音量に達した 最大音量に達した ミュート	V 36 MIN MAX MUTE
<b>オーディオ設定</b>	低音 (+/-) 高音 (+/-) ボイスエンハンス サラウンドエンハンス AI SONIC	BAS LOW / BAS MEDIUM / BAS HIGH TRE LOW / TRE MEDIUM / TRE HIGH VOICE ON / VOICE OFF SURR ON / SURR OFF POSITION 1 / POSITION 2 / POSITION 3 / OFF
<b>サウンドモード</b>	パススルー ナイト	PASS THROUGH / -X- & PASS THROUGH NIGHT ON / NIGHT OFF
<b>サウンドモード</b>	スタンダード/映画/音楽/ ボイス/ゲーム/スポーツ	STANDARD MOVIE MUSIC VOICE GAME SPORTS
<b>ライト</b>	ライト設定	LIGHT 1 / LIGHT 2 / LIGHT 3



사운드바 LED 디스플레이는 다양한 사운드바 기능을 표시합니다.

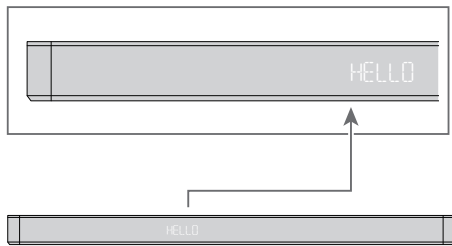

#### 메모:

- 공장 재설정: LED 디스플레이에 "공장 재설정"이 표시될 때까지 바스피커 패널에 있는 세 개의 버튼  $\odot$ ,  $+$  및  $-$ 을 동시에 10초 동안 길게 누른 다음 자동으로 전원을 껐다 켭니다.

	사운드바 상태	LED 디스플레이 상태
전원	전원 켜기 전원 끄기	HELLO STBY / SLEEP
소스	<b>HDMI eARC/ARC</b> 옵티컬 <b>USB</b> 블루투스 <b>HDMI IN</b>	HDMI eARC OPT USB BT HDMI IN
블루투스	<b>Searching(검색) 모드(깜박임)</b> <b>Pairing(페어링) 모드</b>	BT PAIRING
볼륨 조절	볼륨 레벨 최소 볼륨 도달 최대 볼륨 도달 음소거	V 36 MIN MAX MUTE
오디오 설정	저음(+/-) 고음(+/-) 음성 향상 서라운드 향상 AI 소닉  패스투루 야간	BAS LOW / BAS MEDIUM / BAS HIGH TRE LOW / TRE MEDIUM / TRE HIGH VOICE ON / VOICE OFF SURR ON / SURR OFF POSITION 1 / POSITION 2 / POSITION 3 / OFF  PASS THROUGH / -X- & PASS THROUGH NIGHT ON / NIGHT OFF
사운드 모드	표준/영화/음악/음성/ 게임/스포츠	STANDARD MOVIE MUSIC VOICE GAME SPORTS
조명	조명 설정	LIGHT 1 / LIGHT 2 / LIGHT 3



Soundbar LED顯示螢幕顯示各種Soundbar功能。

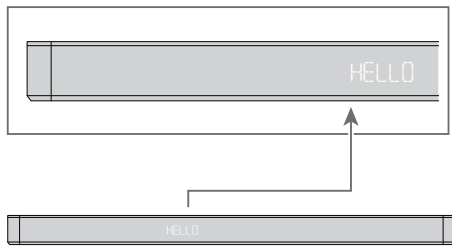

#### 說明：

- 恢復原廠設定：同時長按Soundbar（音量）面板上的 $\odot$ 、+和一三個按鍵10秒，直到LED顯示屏顯示「恢復原廠設定」，然後自動循環開機。

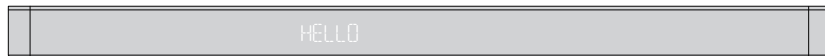

	Soundbar狀態	LED顯示狀態
電源	電源開啓 電源關閉	HELLO STDBY / SLEEP
訊號源	HDMI eARC/ARC 光纖 USB 藍牙 HDMI輸入	HDMI EARC OPT USB BT HDMI IN
藍牙	搜索模式（閃爍） 配對模式	BT PAIRING
音量控制	音量等級 已達到最小音量 已達到最大音量 靜音	V 36 MIN MAX MUTE
音頻設置	低音 (+/-) 高音 (+/-) 語音增強 環繞增強 AI SONIC  通過 夜間	BAS LOW / BAS MEDIUM / BAS HIGH TRE LOW / TRE MEDIUM / TRE HIGH VOICE ON / VOICE OFF SURR ON / SURR OFF POSITION 1 / POSITION 2 / POSITION 3 / OFF  PASS THROUGH / -X- & PASS THROUGH NIGHT ON / NIGHT OFF
聲音模式	標準/電影/音樂/語音/ 遊戲/運動	STANDARD MOVIE MUSIC VOICE GAME SPORTS
燈光	燈光設置	LIGHT 1 / LIGHT 2 / LIGHT 3



Màn hình LED của Loa thanh cho biết nhiều loại chức năng của Loa thanh.

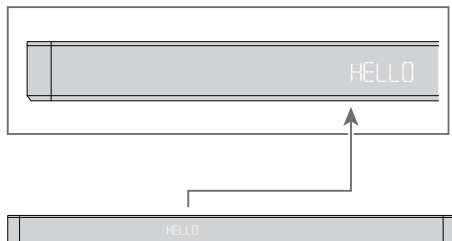

#### Ghi chú:

- **Khôi phục cài đặt gốc:** Nhấn và giữ ba phím  $\ominus$ ,  $+$  và  $\text{---}$  trên bảng Soundbar trong 10 giây cho đến khi màn hình LED hiển thị "FACTORY RESET" và sau đó tự động bật nguồn.



	Trạng thái loa thanh	Trạng thái màn hình LED
<b>Nguồn điện</b>	<b>Bật nguồn</b> <b>Tắt nguồn</b>	HELLO STDBY / SLEEP
<b>Nguồn</b>	<b>HDMI eARC/ARC</b> <b>Quang học</b> <b>USB</b> <b>Bluetooth</b> <b>HDMI IN</b>	HDMI EARC OPT USB BT HDMI IN
<b>Bluetooth</b>	<b>Chế độ tìm kiếm (nhấp nhảy)</b> <b>Chế độ ghép nối</b>	BT PAIRING
<b>Kiểm soát âm lượng</b>	<b>Mức âm lượng</b> <b>Đã đạt âm lượng tối thiểu</b> <b>Đã đạt âm lượng tối đa</b> <b>Im lặng</b>	V 36 MIN MAX MUTE
<b>Cài đặt âm thanh</b>	<b>Tăng/giảm âm trầm</b> <b>Tăng/giảm âm bổng</b> <b>Tăng cường giọng nói</b> <b>Tăng cường âm thanh vòm</b> <b>AI SONIC</b>  <b>Xuyên qua</b> <b>Đêm</b>	BAS LOW / BAS MEDIUM / BAS HIGH TRE LOW / TRE MEDIUM / TRE HIGH VOICE ON / VOICE OFF SURR ON / SURR OFF POSITION 1 / POSITION 2 / POSITION 3 / OFF  PASS THROUGH / -X- & PASS THROUGH NIGHT ON / NIGHT OFF
<b>Chế độ âm thanh</b>	<b>Tiêu chuẩn/Phim/Âm nhạc/</b> <b>Giọng nói/Trò chơi/Thể thao</b>	STANDARD MOVIE MUSIC VOICE GAME SPORTS
<b>Đèn</b>	<b>Cài đặt đèn</b>	LIGHT 1 / LIGHT 2 / LIGHT 3

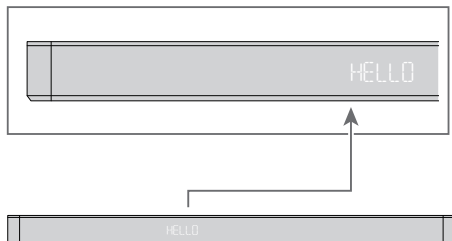

Tampilan LED Soundbar menunjukkan berbagai fungsi Soundbar.



#### Catatan:

- **Reset Setelan Pabrik:** Tekan lama tiga tombol , , dan  pada panel Soundbar secara bersamaan selama 10 detik hingga tampilan LED menunjukkan "RESET SETELAN PABRIK" dan kemudian menyalakan secara otomatis.

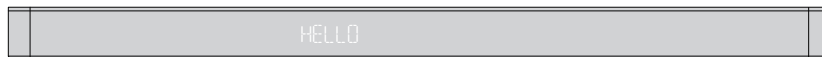

	Status Soundbar	Status Tampilan LED
<b>Daya</b>	<b>Nyala</b> <b>Matikan</b>	HELLO STDBY / SLEEP
<b>Sumber</b>	<b>HDMI eARC/ARC</b> <b>Optik</b> <b>USB</b> <b>Bluetooth</b> <b>HDMI IN</b>	HDMI eARC OPT USB BT HDMI IN
<b>Bluetooth</b>	<b>Mode pencarian (berkedip)</b> <b>Mode berpasangan</b>	BT PAIRING
<b>Kontrol volume</b>	<b>Level volume</b> <b>Volume minimum tercapai</b> <b>Volume maksimum tercapai</b> <b>Bisu</b>	V 36 MIN MAX MUTE
<b>Pengaturan audio</b>	<b>Bass (+/-)</b> <b>Treble (+/-)</b> <b>Peningkatan Suara</b> <b>Peningkatan Keliling</b> <b>AI SONIC</b>  <b>Lewati Malam</b>	DBS LOW / DBS MEDIUM / DBS HIGH TRE LOW / TRE MEDIUM / TRE HIGH VOICE ON / VOICE OFF SURR ON / SURR OFF POSITION 1 / POSITION 2 / POSITION 3 / OFF  PASS THROUGH / -X- & PASS THROUGH NIGHT ON / NIGHT OFF
<b>Mode suara</b>	<b>Standar/Film/Musik/Suara/Permainan/Olahraga</b>	STANDARD MOVIE MUSIC VOICE GAME SPORTS
<b>Lampu</b>	<b>Pengaturan Lampu</b>	LIGHT 1 / LIGHT 2 / LIGHT 3



จอแสดงผล LED ของ Soundbar แสดงฟังก์ชันต่าง ๆ ของ Soundbar

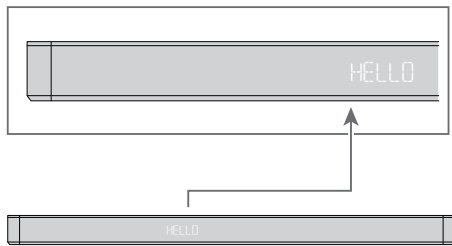

#### บันทึก:

- รีเซ็ตเป็นค่าจากโรงงาน: กดสามปุ่ม  $\ominus$ ,  $+$  และ  $\text{—}$  บนแผงลำโพงบาร์ค้างไว้พร้อมกันเป็นเวลา 10 วินาทีพร้อมกันจนกระทั่งจอแสดงผล LED แสดง "รีเซ็ตเป็นค่าจากโรงงาน" จากนั้นเปิดปิดเครื่องโดยอัตโนมัติ

	สถานะของ Soundbar	สถานะการแสดงผล LED
พลังงาน	เปิดเครื่อง ปิดเครื่อง	HELLO STBY / SLEEP
แหล่งที่มา	HDMI eARC/ARC Optical USB Bluetooth HDMI IN	HDMI eARC OPT USB BT HDMI IN
Bluetooth	โหมด Searching (การค้นหา) (กะพริบ) โหมด Pairing (การจับคู่)	BT PAIRING
การควบคุมระดับเสียง	ระดับเสียง ถึงระดับเสียงต่ำสุดแล้ว ถึงระดับเสียงสูงสุดแล้ว ปิดเสียง	V 36 MIN MAX MUTE
การตั้งค่าเสียง	เบส (+/-) เสียงแหลม (+/-) การเพิ่มคุณภาพเสียง การปรับปรุงเสียงรอบทิศทาง AI SONIC	BAS LOW / BAS MEDIUM / BAS HIGH TRE LOW / TRE MEDIUM / TRE HIGH VOICE ON / VOICE OFF SURR ON / SURR OFF POSITION 1 / POSITION 2 / POSITION 3 / OFF
โหมดเสียง	ผ่านโดยตรง กลางคืน	PASS THROUGH / -X- & PASS THROUGH NIGHT ON / NIGHT OFF
โหมดเสียง	มาตรฐาน/ภาพยนตร์/ เพลง/เสียง/เกม/กีฬา	STANDARD MOVIE MUSIC VOICE GAME SPORTS
แสงสว่าง	การตั้งค่าแสง	LIGHT 1 / LIGHT 2 / LIGHT 3

4

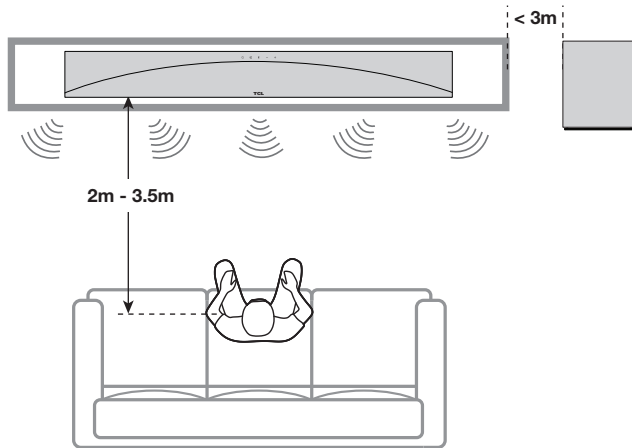

5a



J

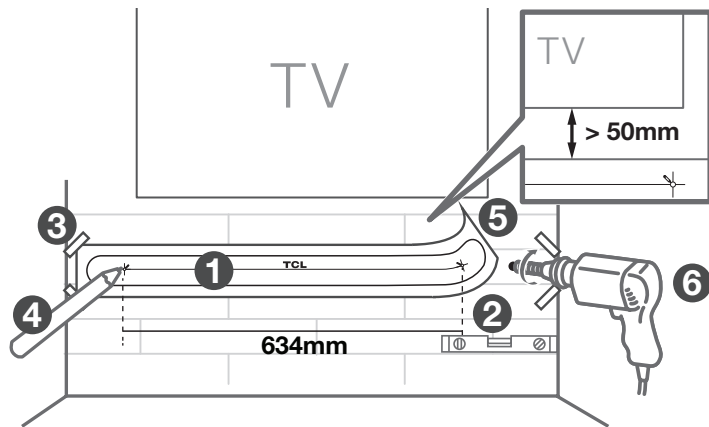
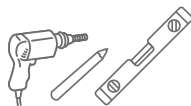
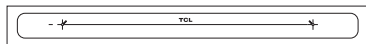

# 5b



F

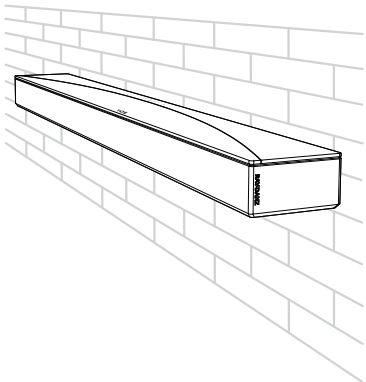
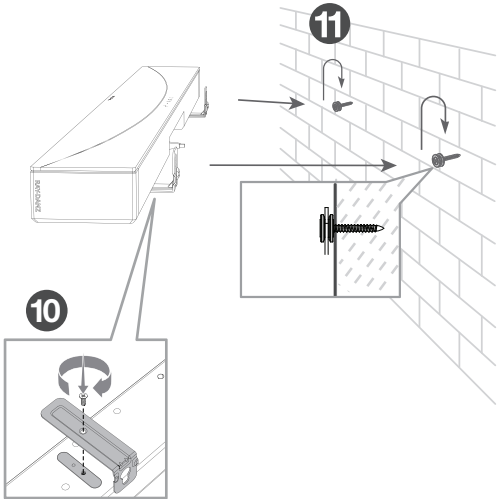
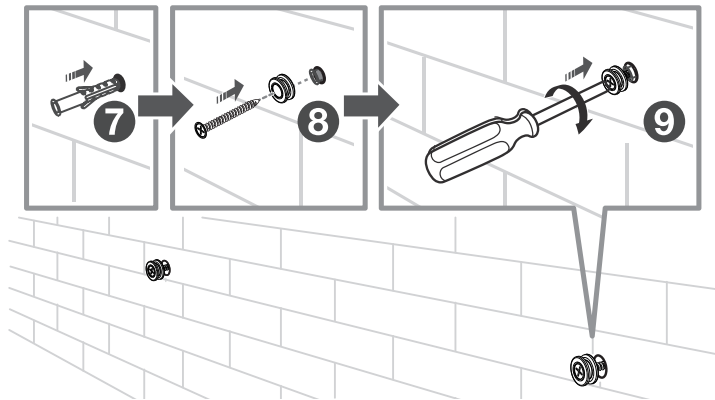
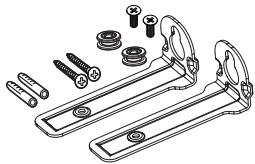

6



Battery type: 1.5V AAA battery x 2

E

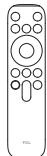

Warning: Do not expose batteries to excessive heat such as sunshine, fire, or the like. Keep new and used batteries away from children. For disposal or recycling information, please contact your local authorities.



CAUTION: Danger of explosion if the battery is incorrectly replaced. Replace only with the same or equivalent type.

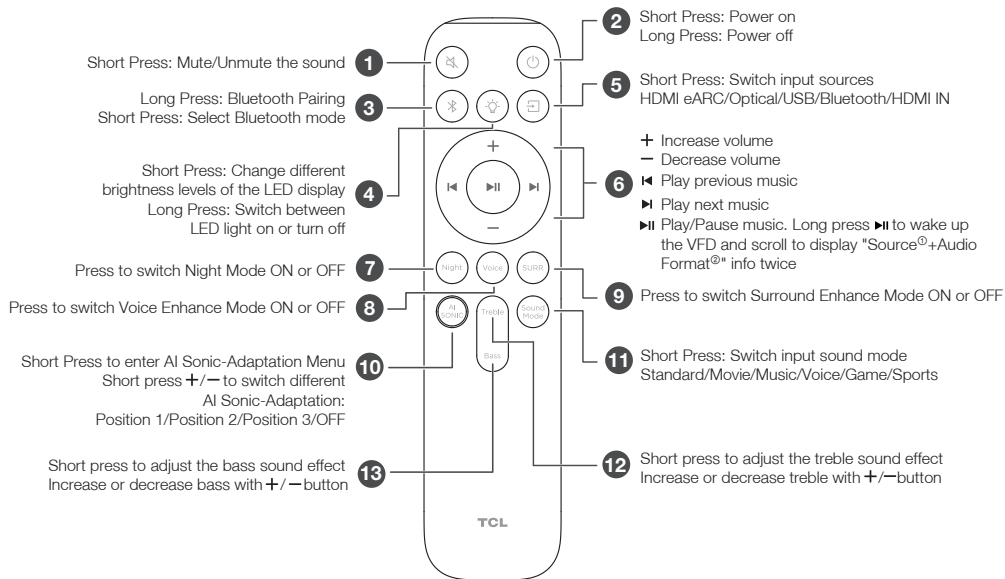
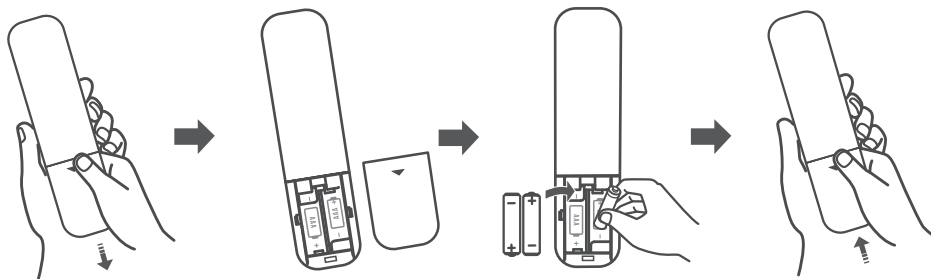

Note:

① Source: HDMI eARC/Optical/USB/Bluetooth/HDMI IN/AirPlay Ready

② Audio Format: PCM AUDIO/DOLBY SURROUND/DOLBY ATMOS/DTS/DTS HD/DTS:X, etc.

6



Type de batterie : Batterie AAA 1,5V x 2

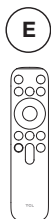

**!** Avertissement : N'exposez pas les batteries à une chaleur excessive, tel que le soleil, le feu, etc. Gardez les batteries neuves et usagées hors de portée des enfants. Pour obtenir des informations sur l'élimination ou le recyclage, veuillez contacter les autorités locales.

**!** ATTENTION : Risque d'explosion si la batterie n'est pas correctement remplacée. Remplacez uniquement par le même type ou un type équivalent.

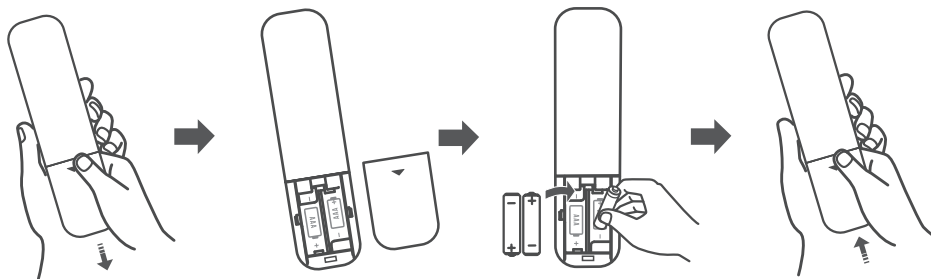

Appui court : Coupure/rétablissement du son **1**

Appui long : Appairage de Bluetooth  
Appui court : Sélectionner le mode Bluetooth **3**

Appui court : Modifier les différents niveaux de luminosité de l'écran LED  
Appui long : Basculer entre l'allumage et l'extinction du voyant LED **4**

Appuyer sur pour activer ou désactiver le mode Nuit **7**

Appuyer sur pour activer ou désactiver le mode Amélioration Voix **8**

Appuyer brièvement pour passer au menu Adaptation Sonique AI  
Appuyer brièvement sur + / - pour passer d'une adaptation sonore AI à l'autre : Position 1/Position 2/Position 3/Arrêt **10**

Appuyer brièvement pour régler l'effet sonore des basses  
Augmenter ou diminuer les basses avec le bouton +/- **13**

**2** Appui court : Mise sous tension  
Appui long : Mise hors tension

**5** Appui court : Changer de source d'entrée HDMI eARC/Optique/USB/Bluetooth/ENTRÉE HDMI  
+ Augmenter le volume  
- Diminuer le volume

**6** ◀ Lecture de la musique précédente  
▶ Lecture de la musique suivante  
⏸ Lecture/Pause de la musique. Appuyez longuement sur ▶ pour réveiller le VFD et faites défiler pour afficher deux fois les informations « Source®+Format Audio® »

**9** Appuyer sur pour activer ou désactiver le mode Amélioration Ambiphonie

**11** Appui court : Changer le mode sonore d'entrée Standard/Film/Musique/Voix/Jeu/Sport

**12** Appuyer brièvement pour régler l'effet sonore des aigus  
Augmenter ou diminuer les aigus avec le bouton +/-

Remarque :

① Source : HDMI eARC/Optical/USB/Bluetooth/HDMI IN/AirPlay Ready

② Format Audio : PCM AUDIO/DOLBY SURROUND/DOLBY ATMOS/DTS/DTS HD/DTS:X, etc.

6



Tipo de batería: batería AAA de 1,5 V x 2

E

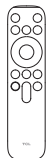

**!** Advertencia: No exponga las baterías al calor excesivo, como la luz del sol, el fuego o similares. Mantenga las baterías nuevas y usadas fuera del alcance de los niños. Para obtener información de eliminación y reciclaje, comuníquese con las autoridades locales.

**!** PRECAUCIÓN: Peligro de explosión si la batería se reemplaza incorrectamente. Reemplace sólo con el mismo tipo o equivalente.

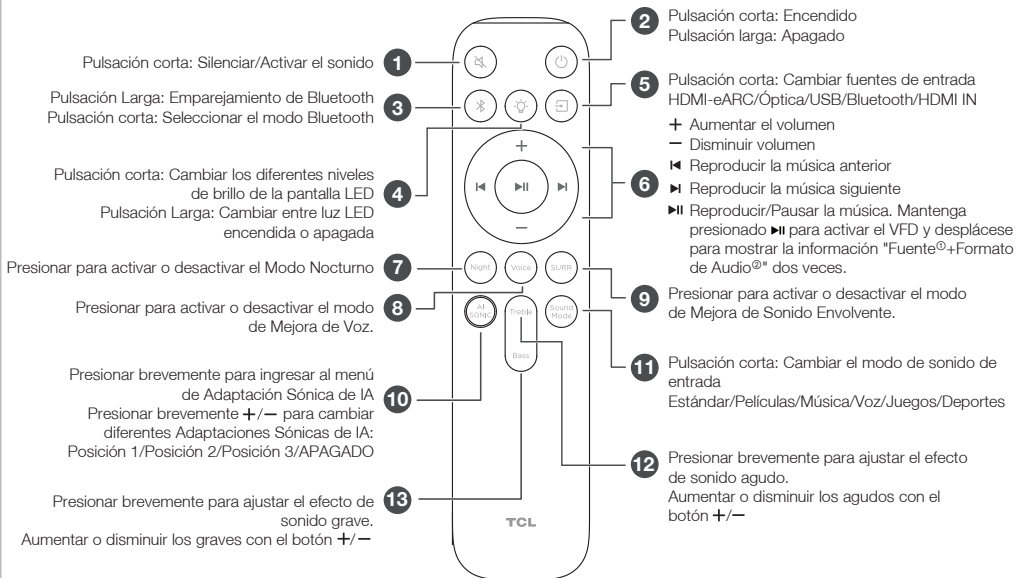
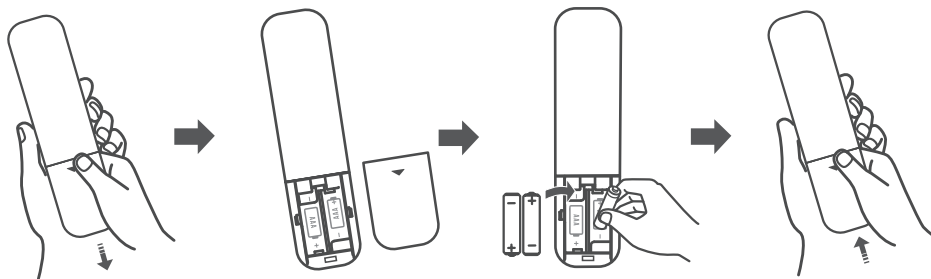

Nota:

① Fuente: HDMI eARC/Optical/USB/Bluetooth/HDMI IN/AirPlay Ready

② Formato de Audio: PCM AUDIO/DOLBY SURROUND/DOLBY ATMOS/DTS/DTS HD/DTS:X, etc.

6



Tipo de bateria: bateria AAA de 1,5 V x 2

E

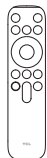

Aviso: Não exponha as baterias a calor excessivo, como a luz solar, o fogo ou similares. Mantenha as baterias novas e usadas longe do alcance de crianças. Para obter informações sobre descarte ou reciclagem, por favor, contacte as autoridades locais.



CUIDADO: Há risco de explosão se a bateria for substituída incorretamente. Substitua somente por uma do mesmo tipo ou do tipo equivalente.

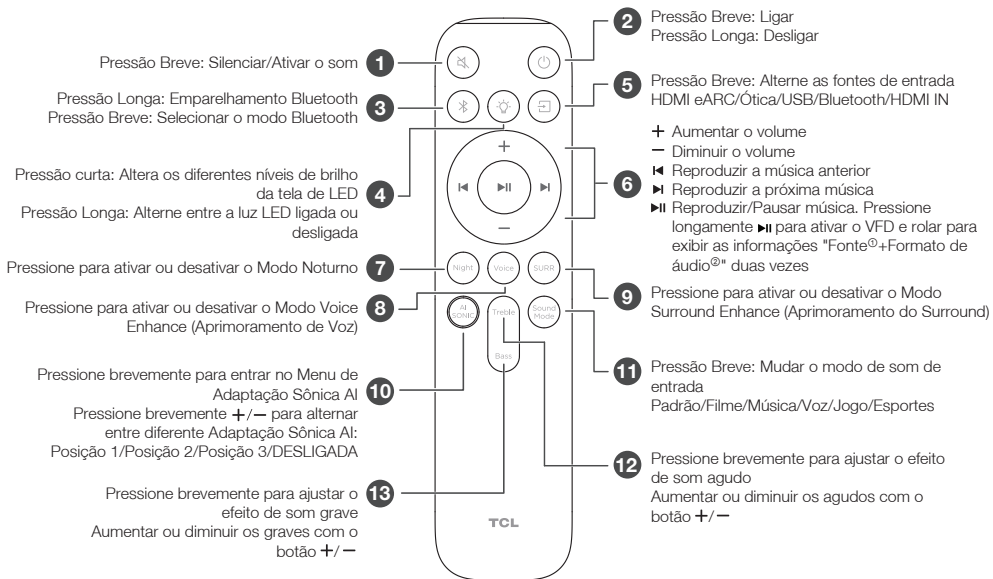
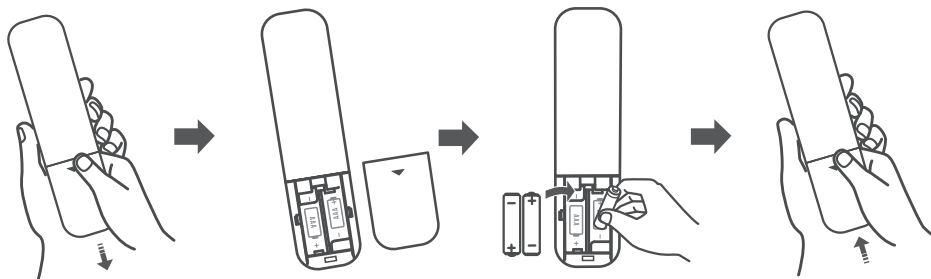

Observação:

① Fonte: HDMI eARC/Optical/USB/Bluetooth/HDMI IN/AirPlay Ready

② Formato de áudio: PCM AUDIO/DOLBY SURROUND/DOLBY ATMOS/DTS/DTS HD/DTS:X, etc.



نوع البطارية: البطارية بنوع AAA فولت 1.5 بـ 2X

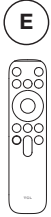

⚠ تنبيه: لا تعرض البطاريات للحرارة الزائدة مثل أشعة الشمس أو النار أو ما شابه. احتفظ بالبطاريات الجديدة والمستعملة بعيدًا عن متناول الأطفال. للحصول على معلومات حول التخلص أو إعادة التدوير، يرجى الاتصال بالسلطات المحلية.

⚠ حذر: يوجد خطر الانفجار إذا تم استبدال البطارية بشكل غير صحيح. استبدل بنفس النوع أو ما يعادلها فقط.

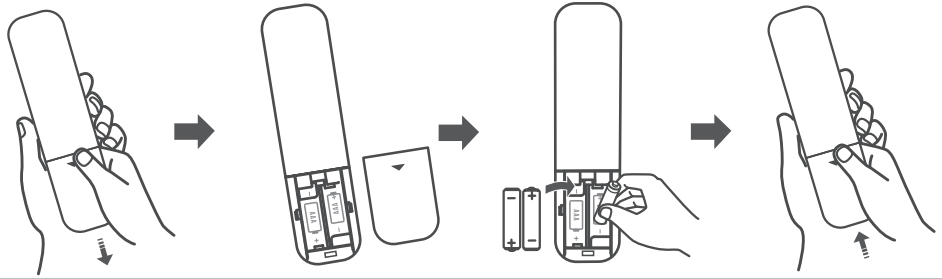

1 اضغط لفترة قصيرة على: كتم/إلغاء كتم الصوت  
3 اضغط لفترة طويلة على: اقتران Bluetooth  
اضغط لفترة قصيرة على: حدد وضع Bluetooth

4 اضغط لفترة قصيرة: تغيير مستويات السطوع  
المختلفة لشاشة LED  
اضغط لفترة طويلة: التبديل بين ضوء LED أو إيقاف تشغيله

7 اضغط على للتبديل الوضع الليلي أو إيقاف تشغيله

8 اضغط لتشغيل وضع تحسين الصوت أو إيقاف تشغيله

10 اضغط لفترة قصيرة للدخول إلى قائمة تكيف AI Sonic  
اضغط لفترة قصيرة على + / - لتبديل تكيف AI Sonic  
المختلف:  
الموضع 1/الموضع 2/الموضع 3/إيقاف

13 اضغط لفترة قصيرة لضبط تأثير صوت باس  
قم بزيادة أو تخفيض تأثير صوت باس بزر + / -

اضغط لفترة قصيرة على: تشغيل الطاقة  
اضغط لفترة طويلة على: إيقاف تشغيل الطاقة

5 اضغط لفترة قصيرة: تبديل مصادر الإدخال  
HDMI IN/Bluetooth/USB/يصري/HDMI eARC

+ زيادة حجم الصوت  
- تقليل حجم الصوت

⏪ تشغيل الموسيقى السابقة  
⏩ تشغيل الموسيقى التالية

⏸ تشغيل الموسيقى/إيقافها مؤقتًا. اضغط لفترة طويلة على  
لإيقاف محرك الأقراص ذي التردد المتغير وانتقل إلى  
عرض معلومات المصدر +تنسيق الصوت@ مرتين

اضغط لتشغيل وضع تحسين الصوت المحيطي أو إيقاف تشغيله

11 اضغط لفترة قصيرة على: تبديل وضع إدخال الصوت  
قياسي / فيلم / موسيقى / صوت / لعبة / رياضة

12 اضغط لفترة قصيرة على لضبط تأثير الصوت بالتردد  
العالي  
قم بزيادة أو تقليل تأثير الصوت بالتردد العالي بزر + / -

ملاحظة:

① المصدر: HDMI eARC/Optical/USB/Bluetooth/HDMI IN/AirPlay Ready  
② تنسيق الصوت: PCM AUDIO/DOLBY SURROUND/DOLBY ATMOS/DTS/DTS HD/DTS:X، إلخ.

## 6



電池の種類：1.5V電池 x 2

E

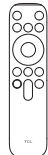

**警告：**  
電池を日光や火気などの過度の熱にさらさないでください。

使用済み・未使用の電池は子どもが届かない場所に保管してください。  
廃棄やリサイクルについては、お住まいの地域の自治体にお問い合わせください。



**注意事項：**爆発の危険があるため、電池を正しい方法に従って交換してください。同一機種または同等品と交換してください。

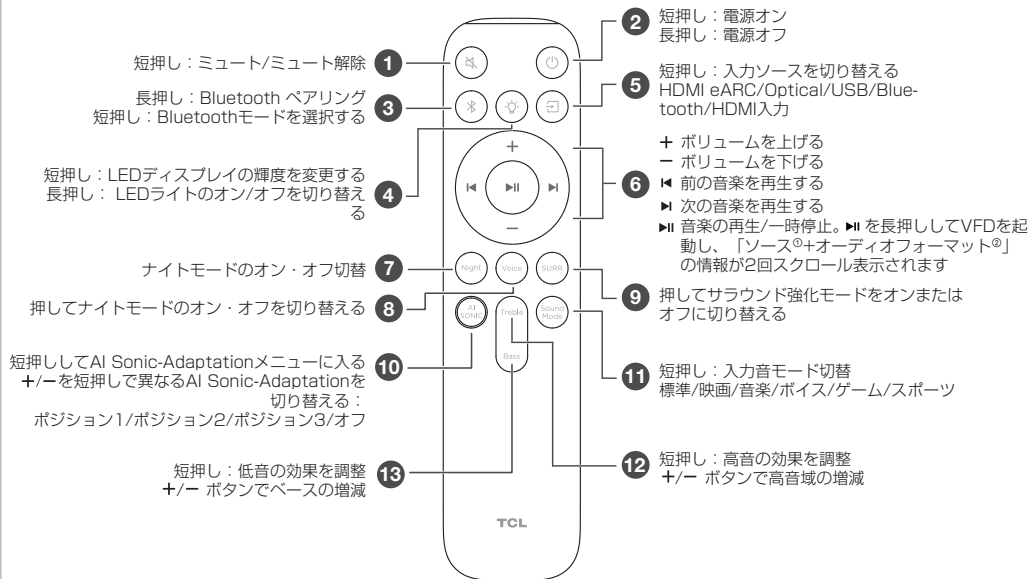
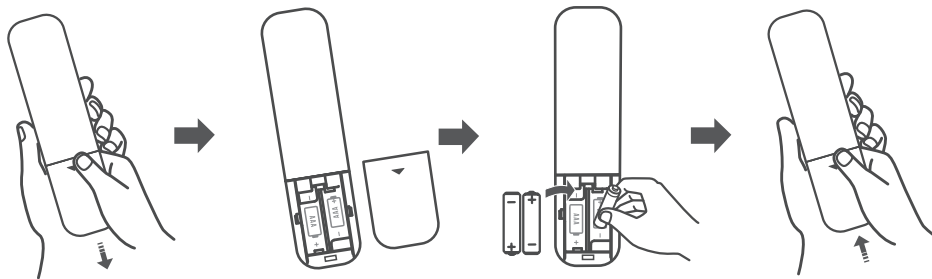

注意：

① ソース：HDMI eARC/Optical/USB/Bluetooth/HDMI IN/AirPlay Ready

② オーディオフォーマット：PCM AUDIO/DOLBY SURROUND/DOLBY ATMOS/DTS/DTS HD/DTS:Xなど。



배터리 유형: 1.5V AAA 배터리 x 2

E

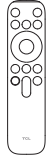

**경고:** 배터리를 햇빛, 불 등과 같은 과도한 열에 노출시키지 마십시오. 새로운 및 사용된 배터리를 어린이에게서 멀리 보관하십시오. 폐기 또는 재활용 정보에 대해 현지 주관부서에 문의하십시오.

**주의:** 배터리를 잘못 교체하면 폭발할 위험이 있습니다. 동일하거나 동등한 유형으로만 교체하십시오.

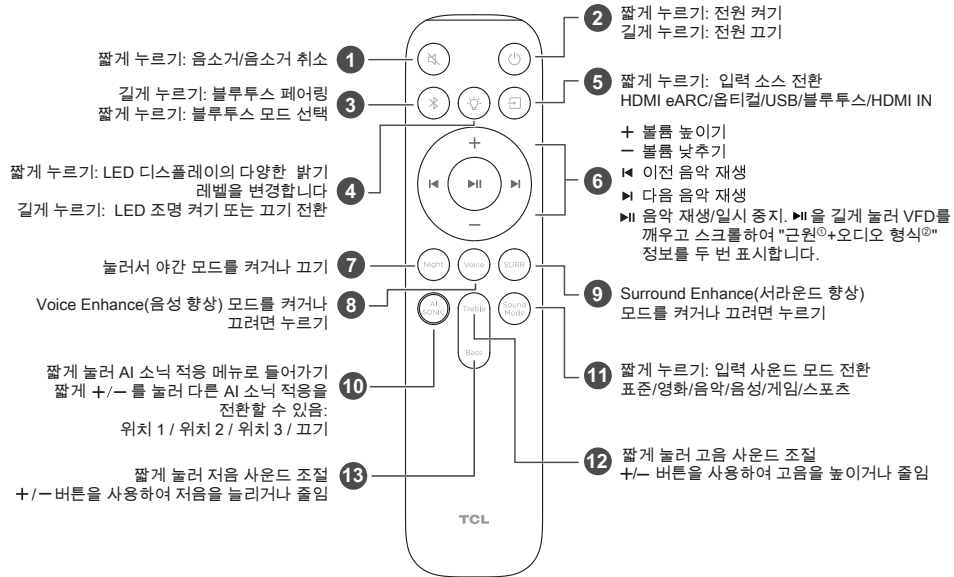
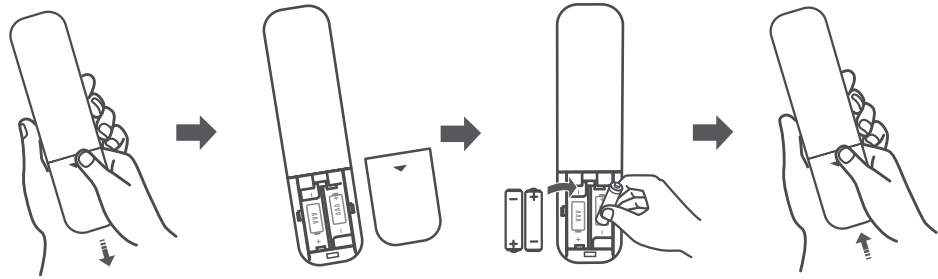

참고:

① 근원: HDMI eARC/Optical/USB/Bluetooth/HDMI IN/AirPlay Ready

② 오디오 형식: PCM AUDIO/DOLBY SURROUND/DOLBY ATMOS/DTS/DTS HD/DTS:X 등

6



電池類型：1.5V AAA電池×2

E



**警告：**請勿將電池暴露在過熱環境中，如陽光、火等。請將新的和用過的電池放在兒童接觸不到的地方。有關處置或者回收資訊，請聯繫當地政府。

**注意：**如果電池更換不當，有爆炸危險。只能使用相同或者等效的型號進行更換。

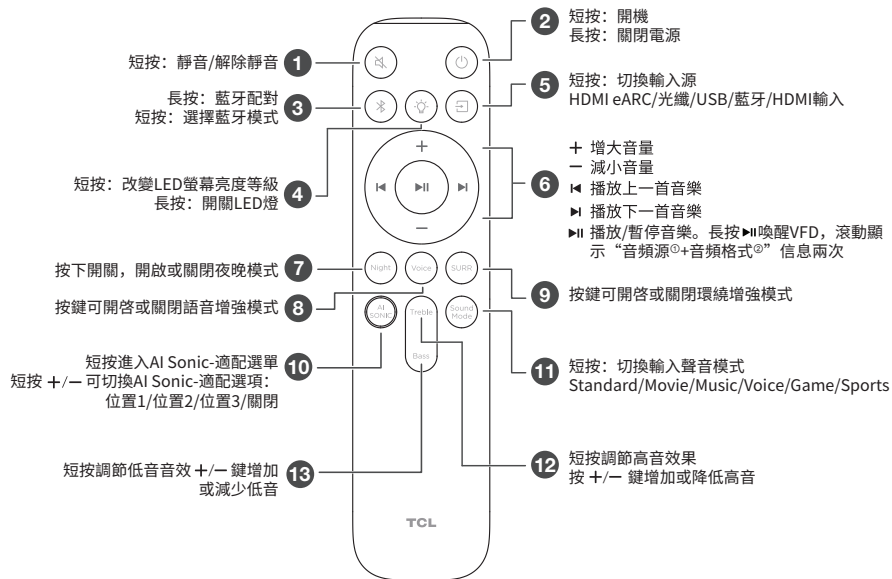
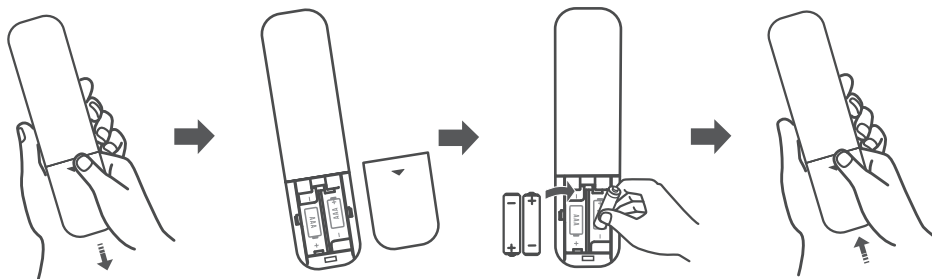

說明：

ⓐ 音頻源：HDMI eARC/Optical/USB/Bluetooth/HDMI IN/AirPlay Ready

ⓑ 音頻格式：PCM AUDIO/DOLBY SURROUND/DOLBY ATMOS/DTS/DTS HD/DTS:X等

6



Loại pin: Pin AAA 1,5V x 2

E

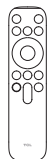

**!** Cảnh báo: Pin không được tiếp xúc với nhiệt độ cao như ánh nắng, lửa hoặc các nguồn nhiệt tương tự. Giữ pin mới và đã sử dụng tránh xa trẻ em. Để biết thông tin về việc loại bỏ hoặc tái chế, vui lòng liên hệ với chính quyền địa phương của bạn.

**!** THẬN TRỌNG: Nguy cơ nổ nếu thay pin không chính xác. Chỉ thay bằng cùng loại hoặc tương đương.

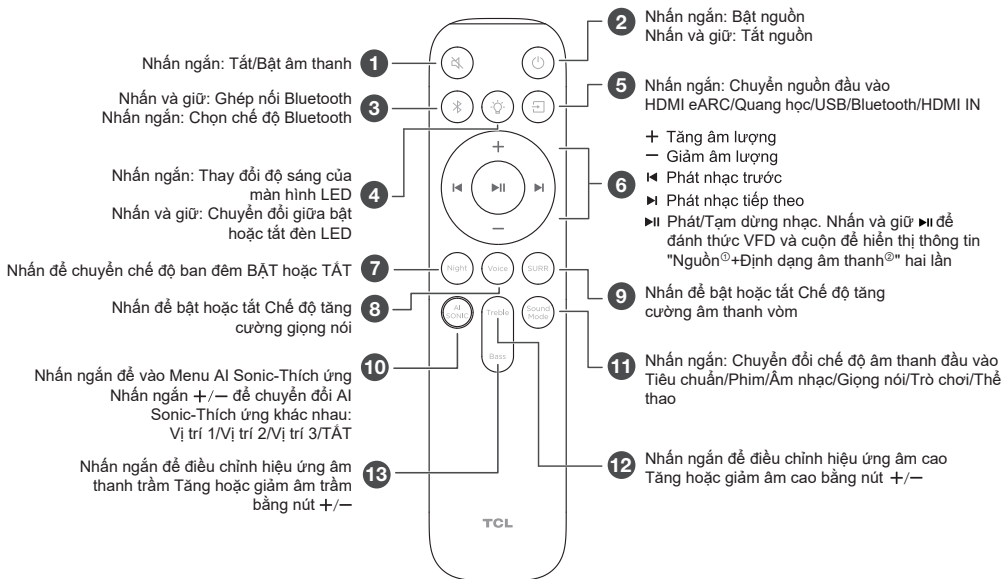
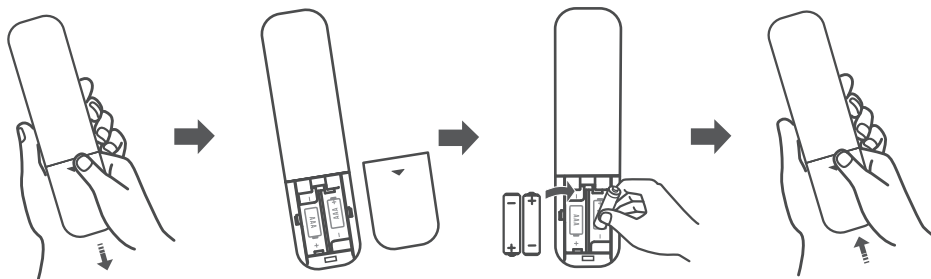

Lưu ý:

① Nguồn: HDMI eARC/Optical/USB/Bluetooth/HDMI IN/AirPlay Ready

② Định dạng âm thanh: PCM AUDIO/DOLBY SURROUND/DOLBY ATMOS/DTS/DTS HD/DTS:X v.v.

6



Jenis baterai: Baterai AAA 1,5V x 2

E

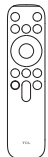

Peringatan: Jangan biarkan baterai terkena panas yang berlebihan seperti sinar matahari, api, atau sejenisnya. Jauhkan baterai baru dan bekas dari jangkauan anak-anak. Untuk informasi pembuangan atau daur ulang, silakan hubungi pihak berwenang setempat.



PERHATIAN: Bahaya ledakan jika baterai tidak diganti dengan benar. Ganti hanya dengan tipe yang sama atau setara.

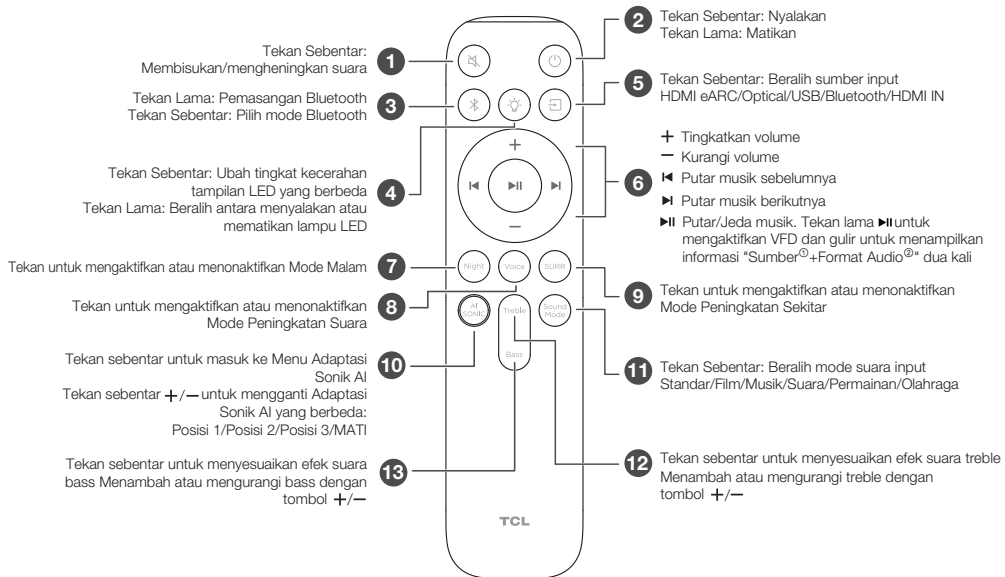
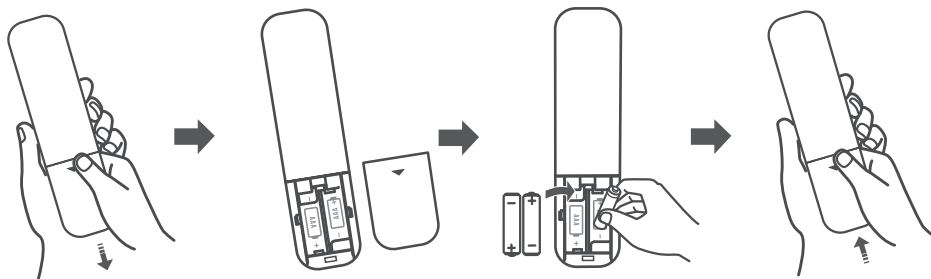

Catatan:

Ⓛ Sumber: HDMI eARC/Optical/USB/Bluetooth/HDMI IN/AirPlay Ready

Ⓜ Format Audio: PCM AUDIO/DOLBY SURROUND/DOLBY ATMOS/DTS/DTS HD/DTS:X, dll.

6



ประเภทแบตเตอรี่: แบตเตอรี่ AAA 1.5V x 2

E

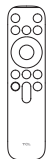

คำเตือน: อย่าให้แบตเตอรี่สัมผัสกับความร้อนที่มากเกินไป เช่น แสงแดด ไฟ หรือสิ่งทีคล้ายกัน เก็บแบตเตอรี่ใหม่และใช้แล้วให้ห่างจากเด็ก สำหรับข้อมูลการกำจัดหรือการรีไซเคิลโปรดติดต่อหน่วยงานในพื้นที่ของคุณ



คำเตือน: มีอันตรายที่จะเกิดการระเบิดหากเปลี่ยนแบตเตอรี่ไม่ถูกต้อง แทนที่ด้วยประเภทเดียวกันหรือเทียบเท่าเท่านั้น



nans.

เครื่องวิทยุคมนาคมนี้ ได้รับความคุ้มครอง ไม่ต้องได้รับใบอนุญาตให้มี ใช้ซึ่งเครื่องวิทยุคมนาคมหรือตั้งสถานีวิทยุคมนาคมตามประกาศ กสทช. เรื่อง เครื่องวิทยุคมนาคม และสถานีวิทยุคมนาคมที่ได้รับยกเว้นไม่ต้องได้รับใบอนุญาตวิทยุคมนาคมตามพระราชบัญญัติวิทยุคมนาคม พ.ศ. 2498



nans. | โทรคมนาคม

กำกับดูแลเพื่อประชาชน

Call Center 1200 (InswS)

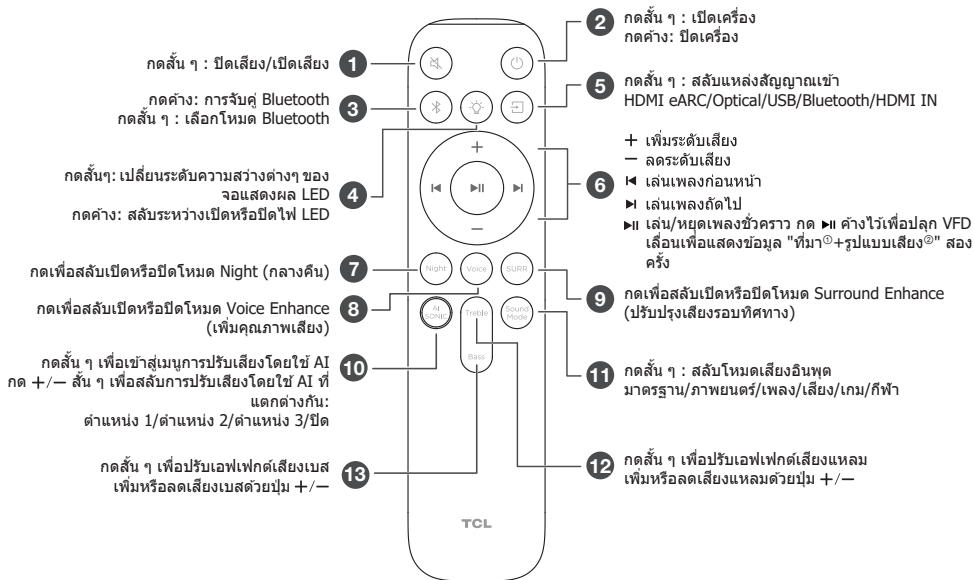
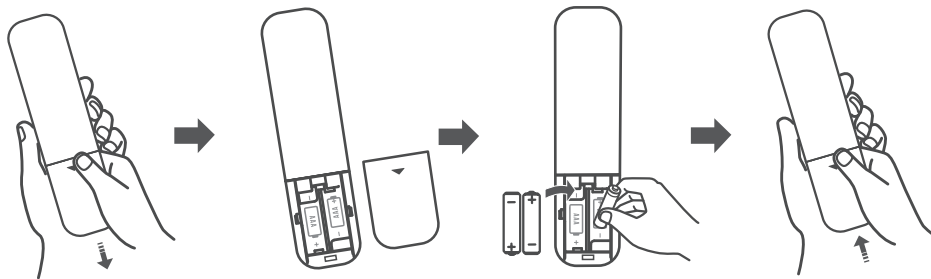

หมายเหตุ:

① ที่มา: HDMI eARC/Optical/USB/Bluetooth/HDMI IN/AirPlay Ready

② รูปแบบเสียง: PCM AUDIO/DOLBY SURROUND/DOLBY ATMOS/DTS/DTS HD/DTS:X เป็นต้น

# 7a



**EN** There are 2 ways to connect your soundbar to the TV (listed in order that we recommend): HDMI eARC (refer to 7a) and Optical (refer to 7b).

**FR** Vous pouvez connecter de 2 manières votre barre de son au téléviseur (elles sont énumérées dans l'ordre que nous recommandons): HDMI-eARC (voir 7a) et Optique (voir 7b).

**ES** Hay 2 formas de conectar su barra de sonido al televisor (detalladas en el orden en que las recomendamos): HDMI eARC (consulte 7a) y Óptico (consulte 7b).

**PT** Há 2 formas de conectar seu soundbar à TV (listadas na ordem que recomendamos): HDMI-eARC (consulte o item 7a) e óptica (consulte o item 7b).

**AR** هناك اثنين طرق لتوصيل مكبر الصوت بالتلفزيون (مذكورة بالترتيب الذي نوصي به): كابل HDMI eARC (ارجع إلى 7a) وكابل ضوئي (ارجع إلى 7b)

**JP** サウンドバーをテレビに接続する方法は2つあります（推奨順に記載しております）。HDMI eARC（7a参照）、光デジタル（7b参照）

**KR** 다음 두 가지 방법으로 사운드바를 텔레비전에 연결할 수 있습니다(권장 순서로 나열). HDMI eARC(7a 참조) 및 옵티컬(7b 참조)

**CN** 有2種方式將條形聲霸連接到電視機（按我們推薦的順序列出）：HDMI eARC（參見7a）和光纖（參見7b）。

**VN** Có 2 cách để kết nối loa thanh của bạn với TV (được liệt kê theo thứ tự mà chúng tôi đề xuất): HDMI eARC (tham khảo 7a) và Quang học (tham khảo 7b).

**ID** Ada 2 cara untuk menyambungkan soundbar Anda ke TV (diurutkan sesuai urutan yang kami rekomendasikan): HDMI eARC (lihat 7a) dan Optik (lihat 7b).

**TH** มี 2 วิธีในการเชื่อมต่อ soundbar ของคุณกับทีวี (แสดงตามลำดับที่เราแนะนำ): HDMI eARC (อ้างอิงถึง 7a) และ Optical (อ้างอิงถึง 7b)

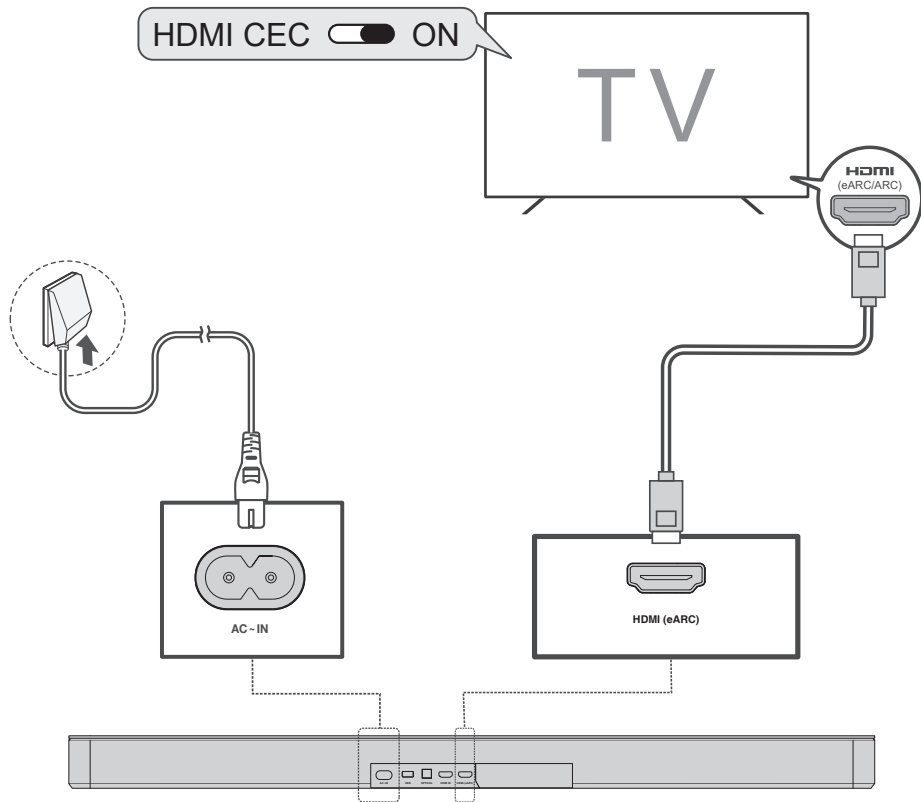

# 7a



**EN** Connect the soundbar with your TV through a HDMI cable.

**FR** Connectez la barre sonore à votre téléviseur au moyen du câble HDMI.

**ES** Conecte la barra de sonido a su televisor a través del cable HDMI.

**PT** Conecte o soundbar à TV por meio do cabo HDMI.

**AR** قم بتوصيل مكبر الصوت بجهاز التلفزيون من خلال كابل HDMI

**JP** サウンドバーをHDMIケーブルでテレビに接続します。

**KR** HDMI 케이블을 통해 사운드바를 텔레비전과 연결합니다.

**CN** 通過HDMI線將條形聲霸與電視機連接起來。

**VN** Kết nối loa thanh với TV của bạn thông qua cáp HDMI

**ID** Sambungkan soundbar dengan TV Anda melalui kabel HDMI

**TH** เชื่อมต่อ soundbar กับทีวีของคุณผ่านสาย HDMI

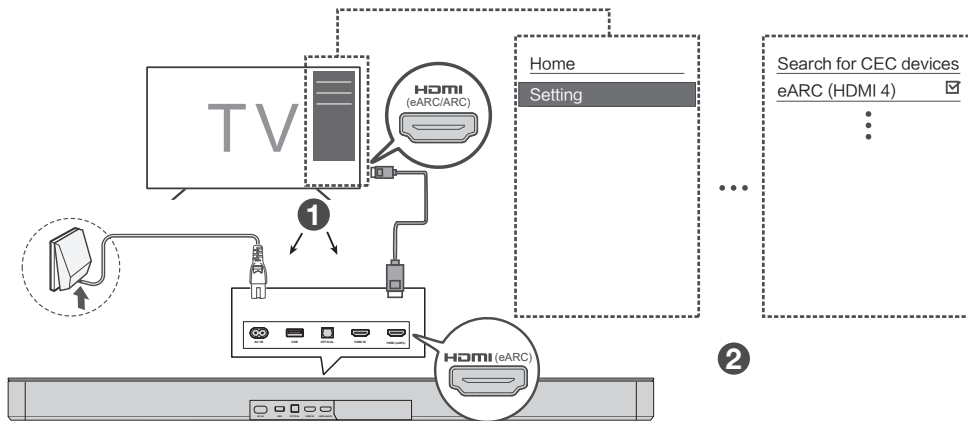
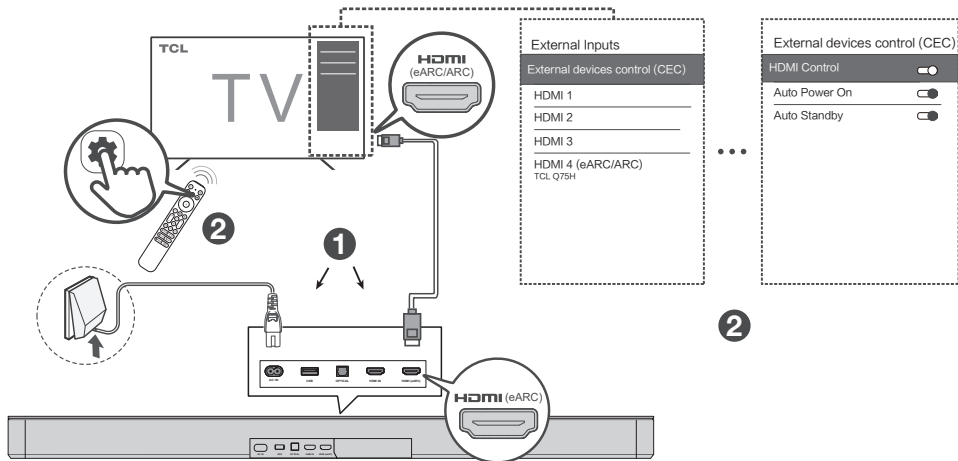



**EN** Connect the soundbar with your TV through the Optical cable (not supplied).

**FR** Connectez la barre sonore à votre téléviseur au moyen du câble optique (non fourni).

**ES** Conecte la barra de sonido a su televisor a través del cable óptico (no suministrado).

**PT** Conecte o soundbar à TV por meio do cabo óptico (não fornecido).

**AR** قم بتوصيل مكبر الصوت بجهاز التلفزيون من خلال كابل ضوئي (غير مرفق).

**JP** 光デジタルケーブル（別売）を介してサウンドバーをテレビに接続します。

**KR** 광케이블(제공되지 않음)을 통해 사운드바를 텔레비전에 연결합니다.

**CN** 通過光纜（需自行購買）將條形聲霸與電視機連接。

**VN** Kết nối loa thanh với TV của bạn thông qua cáp quang (không được cung cấp).

**ID** Sambungkan soundbar dengan TV Anda melalui kabel Optik (tidak disertakan).

**TH** เชื่อมต่อ soundbar กับทีวีของคุณผ่านสาย Optical (ไม่ใส่ให้มา)

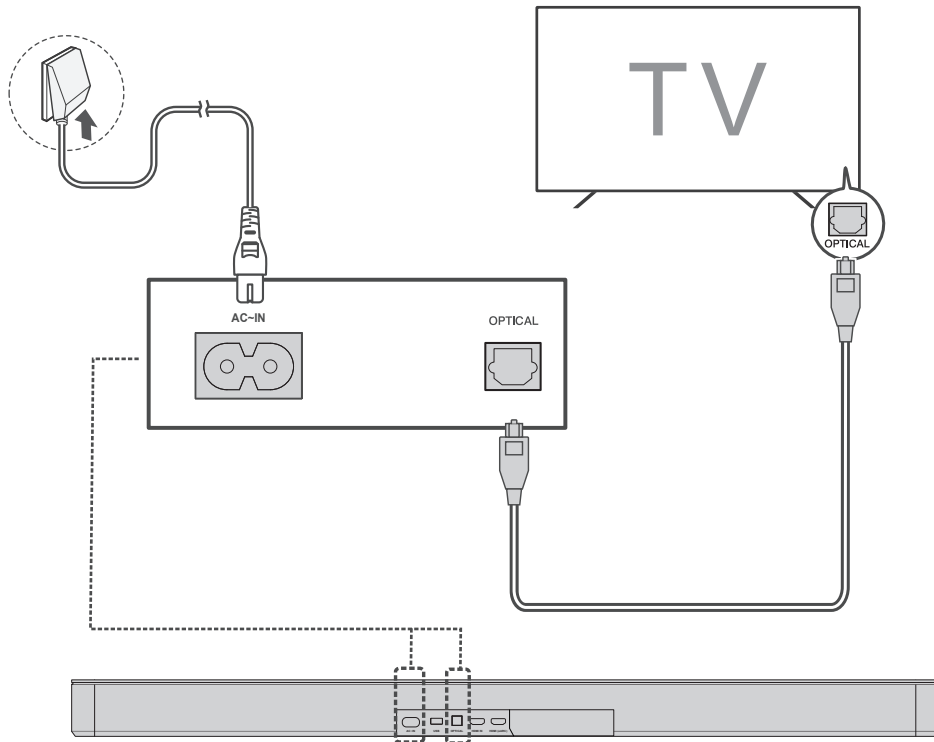



- EN** Select TCL Q75H on your device
- FR** Sélectionnez TCL Q75H sur votre appareil
- ES** Seleccione TCL Q75H en su dispositivo
- PT** Selecione TCL Q75H no seu dispositivo
- AR** حدد TCL Q75H على جهازك
- JP** 接続する機器でTCL Q75Hを選択します
- KR** 장치에서 TCL Q75H를 선택합니다
- CN** 在您的設備上選擇TCL Q75H
- VN** Chọn TCL Q75H trên thiết bị của bạn
- ID** Pilih TCL Q75H pada perangkat Anda
- TH** เลือก TCL Q75H บนอุปกรณ์ของคุณ

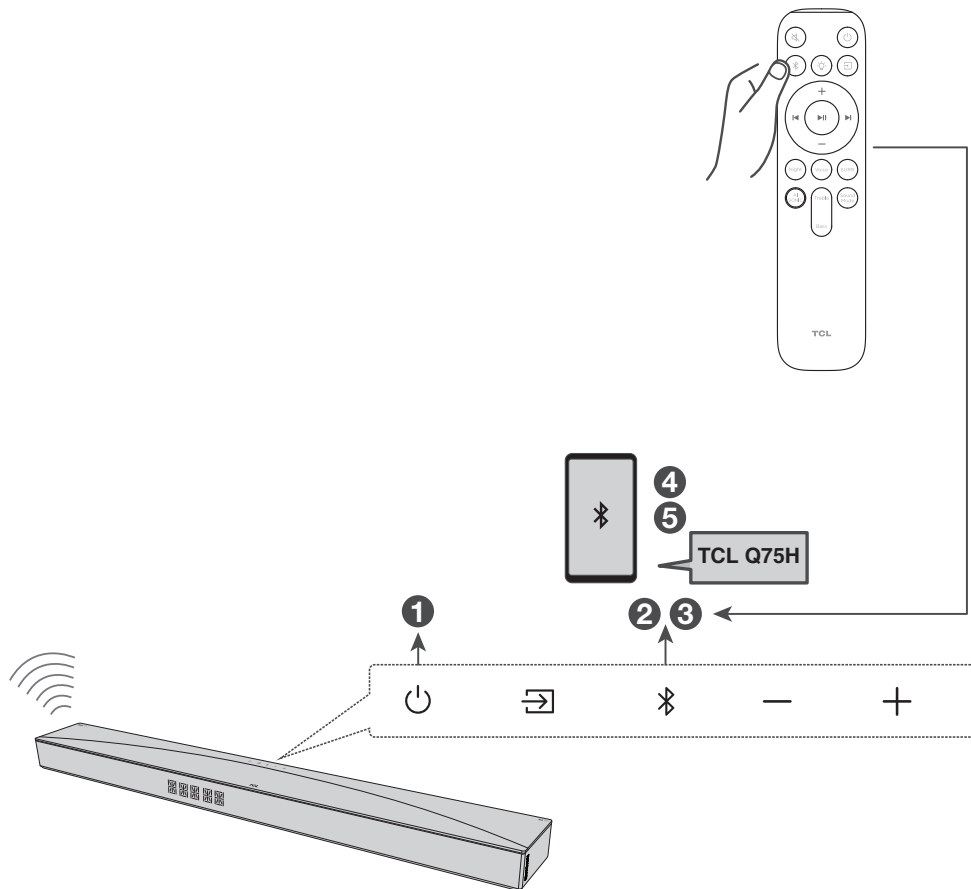

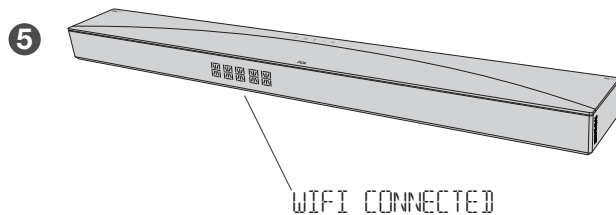
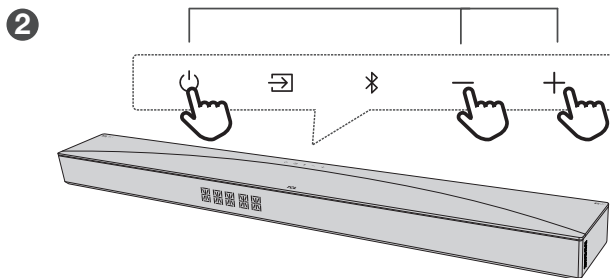
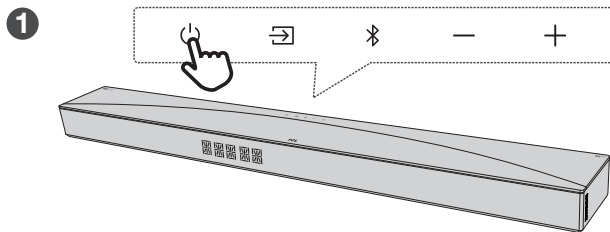



- EN** Supported audio files: MP3, WMA, WAV, FLAC.  
USB format: FAT and FAT 32.
- FR** Fichiers audio compatibles : MP3, WMA, WAV, FLAC.  
Format USB : FAT et FAT 32.
- ES** Archivos de audio compatibles: MP3, WMA, WAV, FLAC.  
Formato USB: FAT y FAT 32.
- PT** Ficheiros de áudio suportados: MP3, WMA, WAV, FLAC.  
Formato USB: FAT e FAT 32.
- AR** .MP3• WMA• WAV• FLAC الملفات الصوتية المدعومة:  
FAT32 و USB: FAT تنسيق
- JP** 対応するオーディオファイル形式 : MP3、WMA、  
WAV、FLAC  
USBフォーマット : FATとFAT 32
- KR** 지원되는 오디오 파일: MP3, WMA, WAV, FLAC.  
USB 포맷: FAT 및 FAT 32.
- CN** 支持音频文件类型: MP3、WMA、WAV、FLAC。  
USB格式: FAT和FAT 32。
- VN** Các tệp âm thanh được hỗ trợ: MP3, WMA, WAV, FLAC.  
Định dạng USB: FAT và FAT 32.
- ID** File audio yang didukung: MP3, WMA, WAV, FLAC.  
Format USB: FAT and FAT 32.
- TH** ไฟล์เสียงที่รองรับ: MP3, WMA, WAV, FLAC  
รูปแบบ USB: FAT และ FAT 32

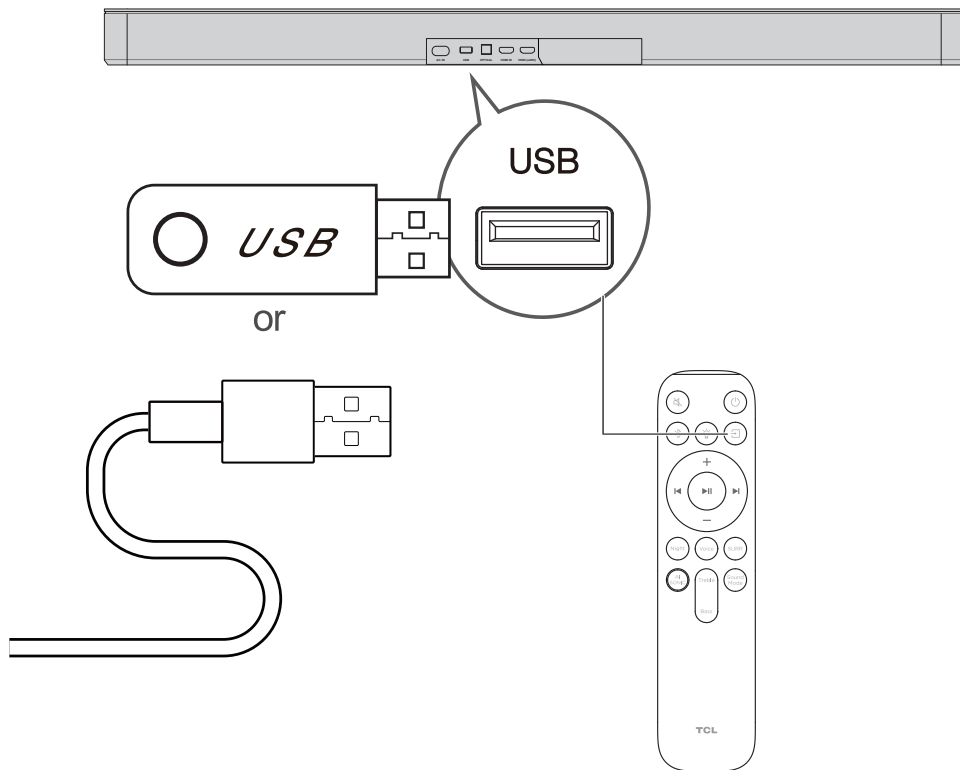



**Settings → Display & Sound → Audio Output →  
Internal Speaker+Soundbar(HDMI)**

**TCL TV**  
Ready

- EN** This function is available in some TCL TVs and some TCL models.  
**FR** Cette fonction est disponible sur certains téléviseurs TCL et certains modèles TCL.  
**ES** Esta función está disponible en algunos televisores de TCL y algunos modelos de TCL.  
**PT** Essa função está disponível em algumas TCL TVs e em alguns modelos TCL.  
**AR** .TCL و بعض أجهزة التلفزيون TCL وبعض موديلات  
**JP** この機能は、一部のTCLテレビおよび一部のTCLモデルで利用できます。  
**KR** 이 기능은 일부 TCL 텔레비전 및 일부 TCL 모델에서 사용할 수 있습니다.  
**CN** 部分TCL電視機和TCL機型包含該功能。  
**VN** Chức năng này có sẵn ở một số TV TCL và một số kiểu máy TCL.  
**ID** Fungsi ini tersedia di beberapa TV TCL dan beberapa model TCL.  
**TH** ฟังก์ชันนี้มีอยู่ในทีวี TCL บางรุ่นและ TCL บางรุ่น

- EN** The message displayed may differ with the TV model.  
**FR** Le message affiché peut varier en fonction du modèle de téléviseur.  
**ES** El mensaje mostrado puede variar según el modelo de TV.  
**PT** A mensagem exibida pode variar de acordo com o modelo da TV.  
**AR** قد تختلف الرسالة المعروضة باختلاف طراز التلفزيون.  
**JP** 表示されるメッセージは、テレビのモデルによって異なる場合があります。  
**KR** 표시되는 메시지는 텔레비전 모델에 따라 다를 수 있습니다.  
**CN** 顯示信息可能因電視機型號而異。  
**VN** Thông báo hiển thị có thể khác nhau tùy theo kiểu TV.  
**ID** Pesan yang ditampilkan mungkin berbeda tergantung model TV.  
**TH** ข้อความที่แสดงอาจแตกต่างกันไปตามรุ่นทีวี

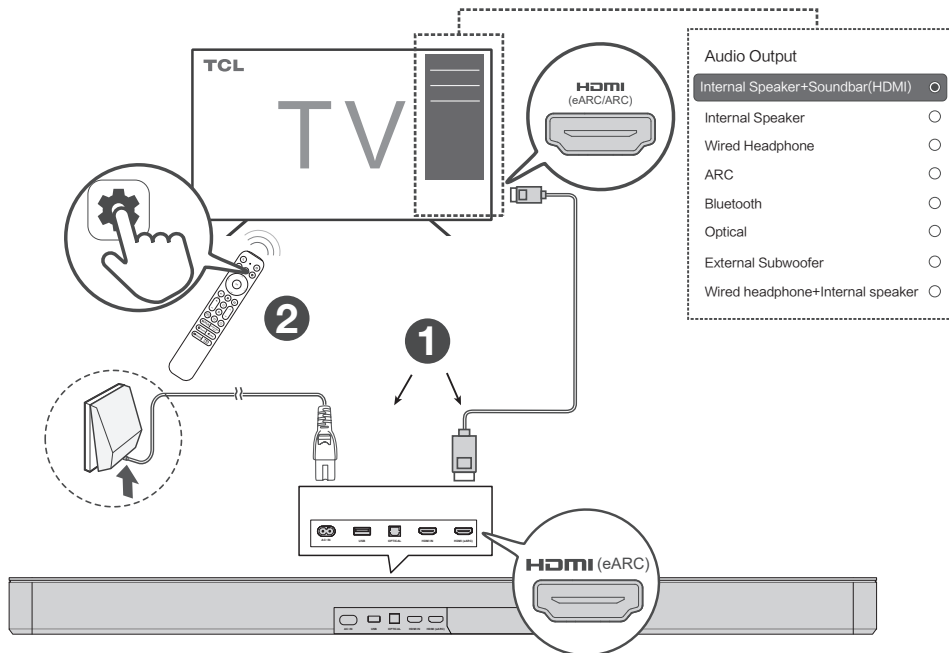

「※本機能は、日本のテレビにはサポートしておりません」

# 12



## TCL HOME



TCL Home App  
Your TCL Smart Hub.  
Download Now!

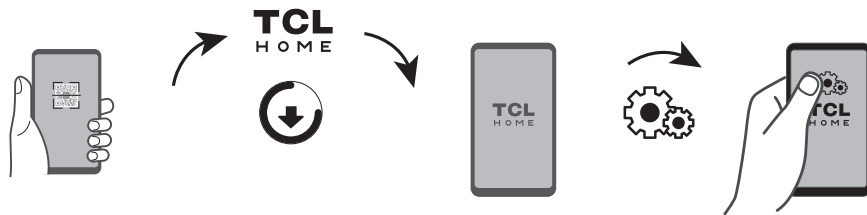

# 13



## AI Sonic-Adaptation

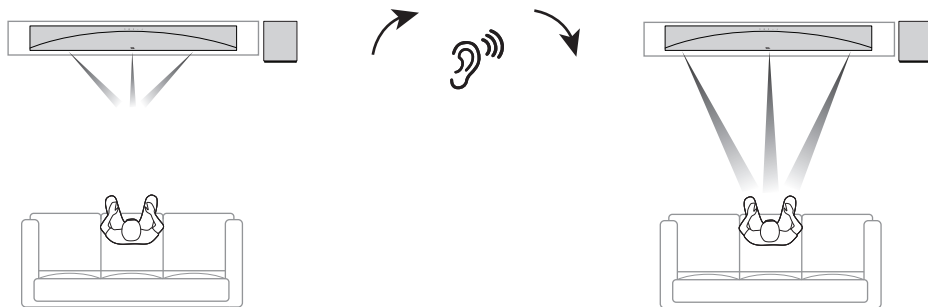

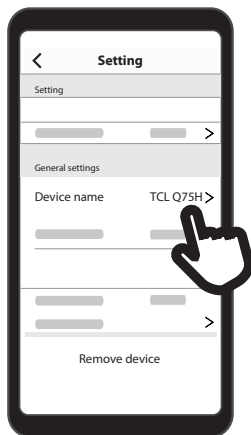

1

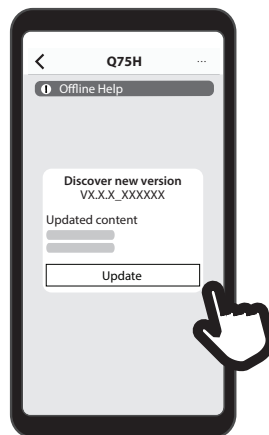

2

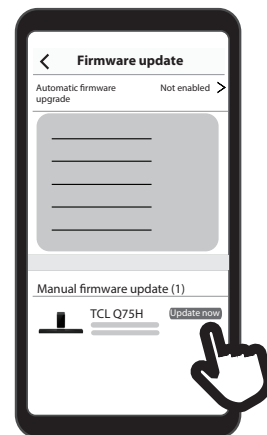

3

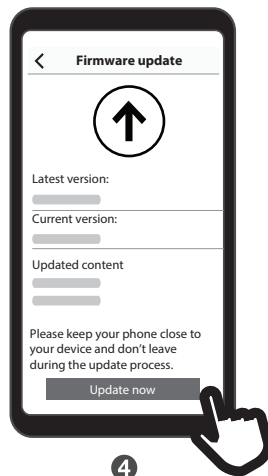

4

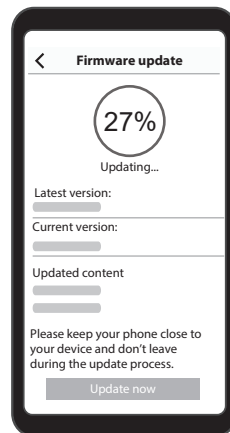

5

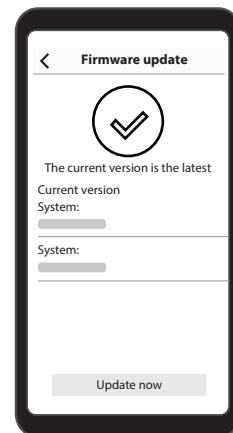

# Trademarks



Apple, AirPlay, Apple Home, and Apple TV are trademarks of Apple Inc., registered in the U.S. and other countries and regions.



Dolby, Dolby Atmos, and the double-D symbol are registered trademarks of Dolby Laboratories Licensing Corporation. Manufactured under license from Dolby Laboratories. Confidential unpublished works. Copyright © 2012-2024 Dolby Laboratories. All rights reserved.



The Bluetooth® word mark and logos are registered trademarks owned by Bluetooth SIG, Inc. and any use of such marks by TTE Corporation is under license. Other trademarks and trade names are those of their respective owners.



For DTS patents, see <http://xperi.com/dts-patents/>. Manufactured under license from DTS Licensing Limited. DTS, DTS:X, and the DTS:X logo are registered trademarks or trademarks of DTS, Inc. in the United States and other countries. © 2024 DTS, Inc. ALL RIGHTS RESERVED.



"The terms HDMI, HDMI High-Definition Multimedia Interface, HDMI trade dress and the HDMI Logos are trademarks or registered trademarks of HDMI Licensing Administrator, Inc."



The Wi-Fi CERTIFIED Logo is a trademark of Wi-Fi Alliance®.

**DO NOT RETURN TO STORE**

**WE ARE  
READY TO  
HELP** contact us first  
with any questions



**TCL SUPPORT:**  
[www.tcl.com](http://www.tcl.com)



**TAKE CARE WHEN  
REMOVING THE SOUND BAR**