

TCL

Q85H

7.1.4 Channel Dolby Atmos Soundbar with Wireless Subwoofer
and Satellite Speakers

回音壁聲學系統

(7.1.4聲道杜比全景聲無線重低音後環繞揚聲器組)

Quick Start Guide

快速設定指南



English | French | Spanish | Portuguese | Arabic | Japanese | Korean | 中文(繁體) |
Vietnamese | Indonesian | Thai



EN Make sure you read all the safety information before you use this product.

- ★ HDMI cable/Optical cable are not available in some locations.
- ★ Power plug design may vary.

FR Assurez-vous d'avoir lu toutes les informations relatives à la sécurité avant d'utiliser cet appareil.

- ★ Le câble HDMI / câble optique ne sont pas disponibles dans certains endroits.
- ★ La conception de la prise d'alimentation peut varier.

ES Asegúrese de leer toda la información de seguridad antes de usar este producto.

- ★ El cable HDMI / cable óptico no están disponibles en algunos lugares.
- ★ El diseño del enchufe de alimentación puede variarse.

PT Leia todas as informações de segurança antes de usar o produto.

- ★ O cabo HDMI/cabo ótico não estão disponíveis em alguns locais.
- ★ O projeto da tomada pode variar.

AR تأكد من قراءة جميع معلومات السلامة قبل استخدام هذا المنتج.
 ★ لا يتوفر كابل HDMI/الكابلات البصرية في بعض المواقع
 ★ تصميم قابس الطاقة يكون مختلفا

JP この製品を使用する前に、すべての安全情報を必ずお読みください。

- ★ HDMIケーブル/光デジタルケーブルは、地域によって使用できない場合があります。
- ★ 電源プラグのデザインは異なる場合があります。

KR 이 제품을 사용하기 전에 모든 안전 정보를 읽으십시오.

- ★ HDMI 케이블/광케이블을 일부 지역에서는 사용할 수 없습니다.
- ★ 전원 플러그 디자인은 다를 수 있습니다.

CN 使用此產品前，請務必閱讀所有安全資料。

- ★ 有些地區不支援HDMI/光纖。
- ★ 電源插頭設計可能有所不同。

VN Hãy chắc chắn rằng bạn đọc tất cả thông tin an toàn trước khi sử dụng sản phẩm này.

- ★ Cáp HDMI/Cáp quang không có sẵn ở một số địa điểm.
- ★ Thiết kế phích cắm điện có thể khác nhau.

ID Pastikan Anda membaca semua informasi keselamatan sebelum menggunakan produk ini.

- ★ Kabel HDMI/Kabel optik tidak tersedia di beberapa lokasi.
- ★ Desain steker listrik mungkin berbeda-beda.

TH ตรวจสอบให้แน่ใจว่าคุณได้อ่านข้อมูลด้านความปลอดภัยทั้งหมดก่อนที่จะใช้ผลิตภัณฑ์นี้

- ★ สาย HDMI/สาย Optical ไม่พร้อมใช้งานในบางพื้นที่
- ★ การออกแบบปลั๊กไฟอาจแตกต่างกันไป

A

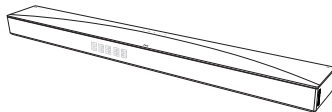

Soundbar
揚聲器主機

B

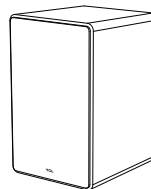

Subwoofer
無線重低音揚聲器

C

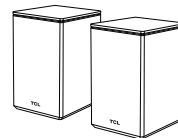

Satellite Speaker x 2
後環繞揚聲器 x 2

D x 4



AC Power cord x 4
交流電源線 x 4

E



HDMI cable
HDMI 纜線

F



Remote Control
遙控器

G

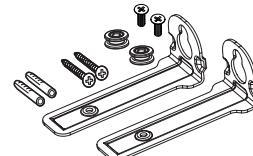

(for Soundbar)
壁掛式工具包
(用於條形聲霸)

H



Quick Start Guide
快速設定指南

I

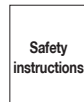

Safety leaflet
安全手冊

J

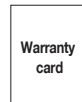

Warranty card
保證書

K

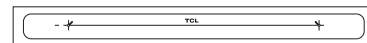

Wall mount template
壁掛式模板

2a



A

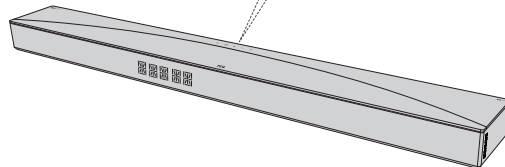
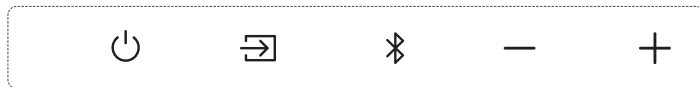
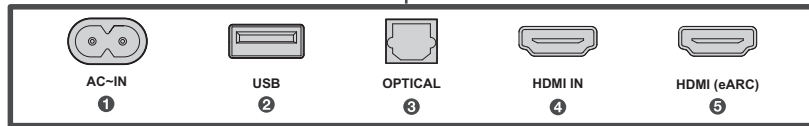
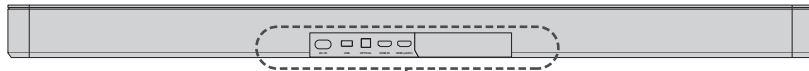
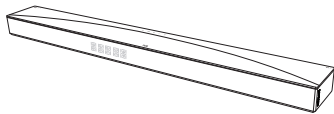

2b



B

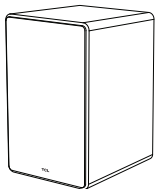

2c



C

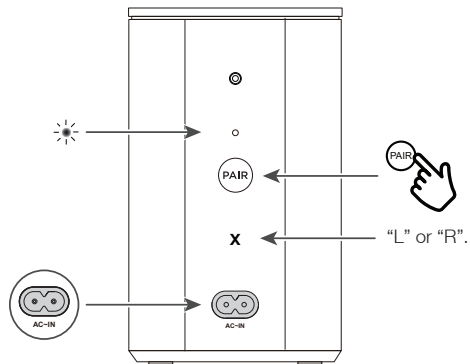
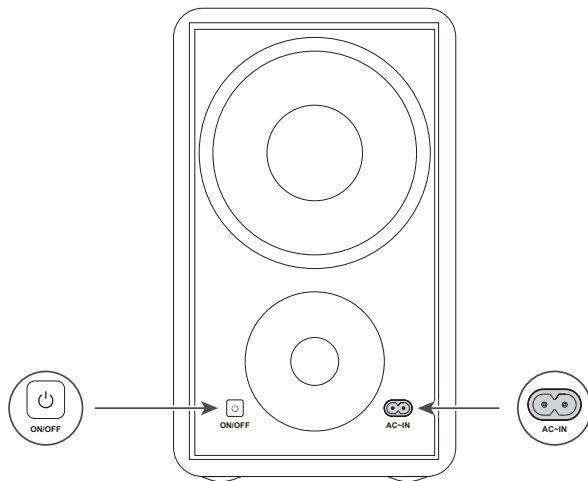
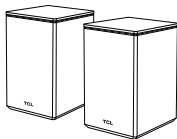



A

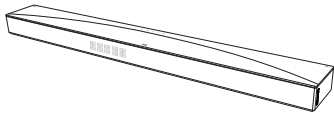

B

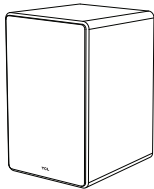

1



>3s



ON/OFF

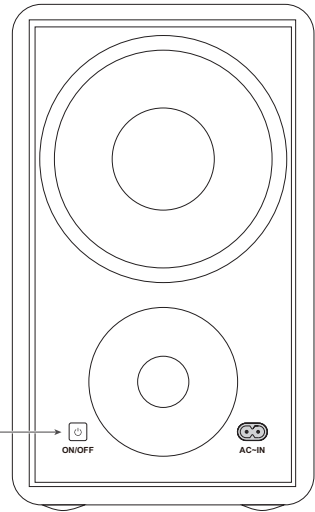

ON/OFF

AC-IN

2

>10s

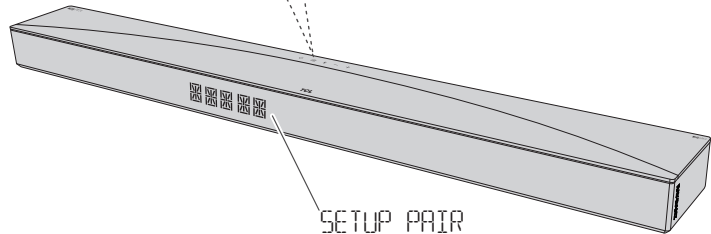

SETUP PAIR

3



The Soundbar LED display indicates various Soundbar functions.

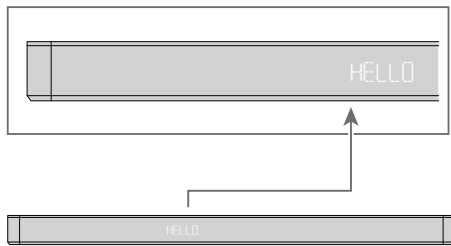

The Light on the top will indicate below scenario status:

1. Power ON: The Light will turn on from the center to the sides.
2. Power OFF: The Light turn on and turn off from the sides to the center.
3. Dolby Atmos format: The Light turn on.
4. VOL +: The Light will gradually turn on from the center to the sides.
5. VOL -: The Light will gradually turn off from the sides to the center.

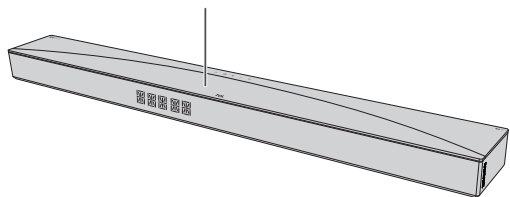

Note:

- **Factory Reset:** Long Press three keys \odot , \oplus and \ominus on the Soundbar panel together for 10s simultaneously till the LED display shows "FACTORY RESET" and then power cycle automatically.



	Soundbar Status	LED Display Status
Power	Power on Power off	HELLO STDBY / SLEEP
Source	HDMI eARC/ARC Optical USB Bluetooth HDMI IN	HDMI eARC OPT USB BT HDMI IN
Bluetooth	Searching mode (flashing) Pairing mode	BT PAIRING
Volume control	Volume level Minimum volume reached Maximum volume reached Mute	V 36 MIN MAX MUTE
Audio setting	Bass (+/-) Treble (+/-) Voice Enhance Surround Enhance Surround Speaker VOL (+/-) AI SONIC Pass Through Night	DPS LOW / DPS MEDIUM / DPS HIGH TRE LOW / TRE MEDIUM / TRE HIGH VOICE ON / VOICE OFF SURR ON / SURR OFF SURR SPK LOW / SURR SPK MEDIUM / SURR SPK HIGH POSITION 1 / POSITION 2 / POSITION 3 / OFF PASS THROUGH / -X- & PASS THROUGH NIGHT ON / NIGHT OFF
Sound modes	Standard/Movie/Music/ Voice/Game/Sports	STANDARD MOVIE MUSIC VOICE GAME SPORTS
Light	Light Setting	LIGHT 1 / LIGHT 2 / LIGHT 3



L'écran LED de la barre de son indique les différentes fonctions de la barre de son.

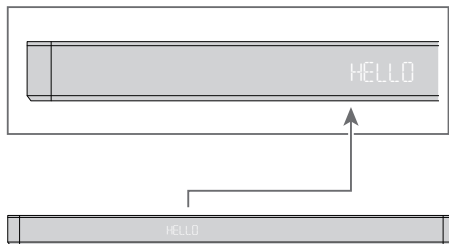

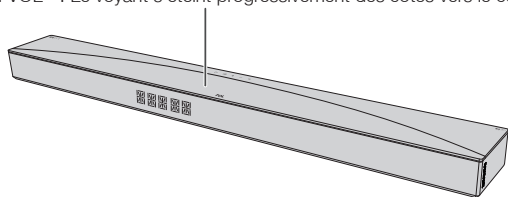

Le voyant situé sur le dessus indique l'état du scénario ci-dessous :

1. Mise sous tension : Le voyant s'allume du centre vers les côtés.
2. Mise hors tension : Le voyant s'allume et s'éteint des côtés vers le centre.
3. Format Dolby Atmos : Le voyant s'allume.
4. VOL + : Le voyant s'allume progressivement du centre vers les côtés.
5. VOL - : Le voyant s'éteint progressivement des côtés vers le centre.



Remarque :

- **Réinitialisation d'usine :** Appuyez longuement sur les trois touches ,  et  du panneau de la barre de son pendant 10 secondes simultanément jusqu'à ce que l'écran LED affiche « FACTORY RESET », puis l'appareil s'éteint automatiquement.



	État de la barre de son	État d'affichage LED
Alimentation	Mise sous tension Mise hors tension	HELLO STDBY / SLEEP
Source	HDMI eARC/ARC Optique USB Bluetooth ENTRÉE HDMI	HDMI eARC OPT USB BT HDMI IN
Bluetooth	Mode de recherche (clignotant) Mode d'appairage	BT PAIRING
Contrôle du volume	Niveau de volume Volume minimal atteint Volume maximal atteint Muet	V 36 MIN MAX MUTE
Réglage audio	Basses (+/-) Aigus (+/-) Amélioration Voix Amélioration Ambiophonie Haut-parleur surround VOL (+/-) SONIQUE AI	BASS LOW / BASS MEDIUM / BASS HIGH TRE LOW / TRE MEDIUM / TRE HIGH VOICE ON / VOICE OFF SURR ON / SURR OFF SURR SPK LOW / SURR SPK MEDIUM / SURR SPK HIGH POSITION 1 / POSITION 2 / POSITION 3 / OFF
	Passer Nuit	PASS THROUGH / -X- & PASS THROUGH NIGHT ON / NIGHT OFF
Modes sonores	Standard/Film/Musique/ Voix/Jeu/Sport	STANDARD MOVIE MUSIC VOICE GAME SPORTS
Voyant	Réglage du voyant	LIGHT 1 / LIGHT 2 / LIGHT 3

3



La pantalla LED de la Barra de Sonido muestra varias funciones de la misma.

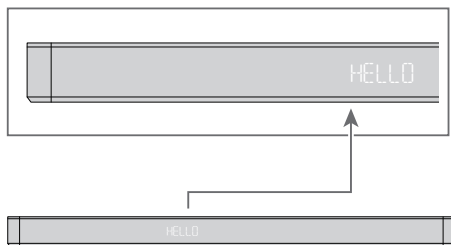

La luz en la parte superior indicará el estado del escenario a continuación:

1. Encendido: Las luces se encienden desde el centro hasta los lados.
2. Apagado: Las luces se encienden y se apagan desde los lados hasta el centro.
3. Formato Dolby Atmos: La luz se enciende.
4. VOL +: Las luces se encenderán gradualmente desde el centro hasta los lados.
5. VOL -: Las luces se apagarán gradualmente desde los lados hasta el centro.

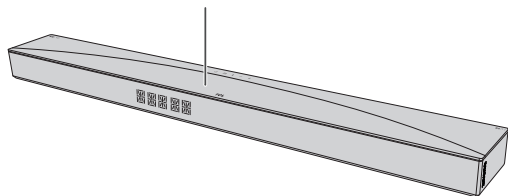

Nota:

- **Restablecimiento de Fábrica:** Mantenga presionadas simultáneamente las tres teclas **⏪**, **+** y **⏩** en el panel de la barra de sonido durante 10 segundos hasta que la pantalla LED muestre "RESTABLECIMIENTO DE FÁBRICA" y luego se apague y encienda automáticamente.

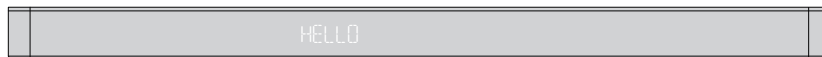

	Estado de Barra de Sonido	Estado de Pantalla LED
Potencia	Encendido Apagado	HELLO STDBY / SLEEP
Fuente	HDMI eARC/ARC Óptica USB Bluetooth HDMI IN	HDMI eARC OPT USB BT HDMI IN
Bluetooth	Modo de búsqueda (parpadeante) Modo de emparejamiento	BT PAIRING
Control del volumen	Nivel de volumen Volumen mínimo alcanzado Volumen máximo alcanzado Silencio	V 36 MIN MAX MUTE
Ajuste de Audio	Graves (+/-) Agudos (+/-) Mejora de Voz Mejora de Sonido Envoltente Volumen del Altavoz Envoltente (+/-)	BAS LOW / BAS MEDIUM / BAS HIGH TRE LOW / TRE MEDIUM / TRE HIGH VOICE ON / VOICE OFF SURR ON / SURR OFF SURR SPK LOW / SURR SPK MEDIUM / SURR SPK HIGH
	AI SONIC	POSITION 1 / POSITION 2 / POSITION 3 / OFF
	Pass Through Nocturno	PASS THROUGH / -X- & PASS THROUGH NIGHT ON / NIGHT OFF
Modos de sonido	Estándar/Películas/Música/ Voz/Juegos/Deportes	STANDARD MOVIE MUSIC VOICE GAME SPORTS
Luz	Ajuste de luz	LIGHT 1 / LIGHT 2 / LIGHT 3



A tela LED da Barra de Som indica vários Funções da Barra de Som.



A luz no topo indicará o estado do cenário abaixo:

1. Ligar: A luz vai acender-se do centro para os lados.
2. Desligar: A luz acende-se e apaga-se dos lados para o centro.
3. Formato Dolby Atmos: A luz acende-se.
4. VOL +: A luz vai acender-se gradualmente do centro para os lados.
5. VOL -: A luz vai apagar-se gradualmente dos lados para o centro.

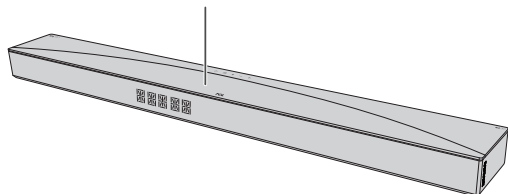

Observação:

- **Redefinição de fábrica:** pressione longamente três botões \cup , $+$ e $-$ no painel do alto-falante de barra juntos por 10s simultaneamente até que o display LED mostre "REDEFINIÇÃO DE FÁBRICA" e, em seguida, desligue e ligue automaticamente.

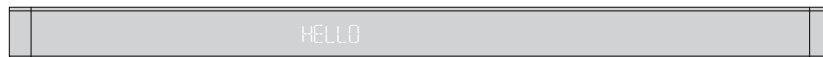

	Estado da Barra de Som	Estado da Tela LED
Energia	Ligar Desligar	HELLO STDBY / SLEEP
Fonte	HDMI eARC/ARC Ótica USB Bluetooth HDMI IN	HDMI eARC OPT USB BT HDMI IN
Bluetooth	Modo Searching (Pesquisa) (intermitente) Modo Pairing (Emparelhamento)	BT PAIRING
Controle do volume	Nível do volume Volume mínimo atingido Volume máximo atingido Mudo	V 36 MIN MAX MUTE
Configuração de áudio	Graves (+/-) Agudos (+/-) Aprimoramento de Voz Aprimoramento do Surround VOL (+/-) do Alto-falante Surround AI SONIC	BAS LOW / BAS MEDIUM / BAS HIGH TRE LOW / TRE MEDIUM / TRE HIGH VOICE ON / VOICE OFF SURR ON / SURR OFF SURR SPK LOW / SURR SPK MEDIUM / SURR SPK HIGH POSITION 1 / POSITION 2 / POSITION 3 / OFF
	Modo de permeabilidade Noite	PASS THROUGH / -X- & PASS THROUGH NIGHT ON / NIGHT OFF
Modos de som	Padrão/Filme/Música/ Voz/Jogos/Espportes	STANDARD MOVIE MUSIC VOICE GAME SPORTS
Luz	Configuração de luz	LIGHT 1 / LIGHT 2 / LIGHT 3



تشير شاشة LED Soundbar إلى وظائف مختلفة لـ Soundbar.

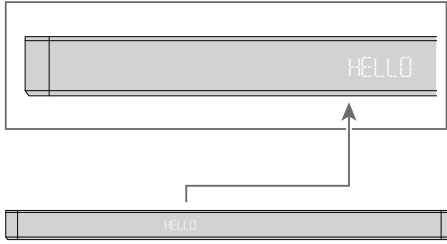

سيشير الضوء الموجود في الأعلى إلى حالة السيناريو أدناه:

1. التشغيل: سيتم تشغيل الضوء من المركز إلى الجوانب.
2. إيقاف التشغيل: يتم تشغيل الضوء وإيقافه من الجوانب إلى المركز.
3. تنسيق Dolby Atmos: يتم تشغيل الضوء.
4. + VOL: سيضيء الضوء تدريجياً من المركز إلى الجوانب.
5. - VOL: سيطفى الضوء تدريجياً من الجوانب إلى المركز.

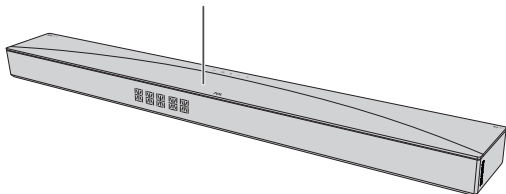

ملحوظة:

- إعادة ضبط المصنع: اضغط لفترة طويلة على ثلاثة أزرار () و + و - على LED لوحة مكبر الصوت معاً لمدة 10 ثوانٍ في وقت واحد حتى تعرض شاشة إعادة ضبط المصنع " ثم دورة الطاقة تلقائياً"



حالة عرض LED	حالة Soundbar		
HELLO STDBY / SLEEP	تشغيل إيقاف التشغيل	الطاقة	
HDMI eARC OPT USB BT HDMI IN	HDMI eARC/ARC بصري USB Bluetooth HDMI IN	مصدر	
BT PAIRING	وضع البحث (امض) وضع الإقتران	Bluetooth	
V 36 MIN MAX MUTE	مستوى الصوت تم الوصول إلى الحد الأدنى للحجم تم الوصول إلى الحد الأقصى للحجم صامت	التحكم في حجم الصوت	
BAS LOW / BAS MEDIUM / BAS HIGH TRE LOW / TRE MEDIUM / TRE HIGH VOICE ON / VOICE OFF SURR ON / SURR OFF SURR SPK LOW / SURR SPK MEDIUM / SURR SPK HIGH POSITION 1 / POSITION 2 / POSITION 3 / OFF	بيس (+/-) صوت مرتفع (+/+) تحسين الصوت التحسين المحيطي صوت مكبر الصوت المحيطي (+/+)	إعدادات الصوت	
PASS THROUGH / -X- & PASS THROUGH NIGHT ON / NIGHT OFF	وضع الصوت المحيط ليلة		
STANDARD MOVIE MUSIC VOICE GAME SPORTS	قياسي/فيلم/موسيقى/صوت/ لعبة/رياضة	أوضاع الصوت	
LIGHT 1 / LIGHT 2 / LIGHT 3	إعدادات الضوء	ضوء	



サウンドバーのLEDディスプレイには、サウンドバーのさまざまな機能が表示されます。

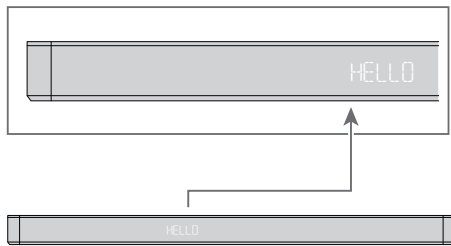

上部のライトは下記通りのシナリオステータスを示します。

- 1.電源オン：ライトは中央から側面に向かって点灯します。
- 2.電源オフ：ライトは側面から中央に向かって点灯・消灯します。
- 3.Dolby Atmosフォーマット：ライトが点灯します。
- 4.VOL +：ライトは中央からサイドに向かって徐々に点灯します。
- 5.VOL -：ライトは側面から中央に向かって徐々に消灯します。

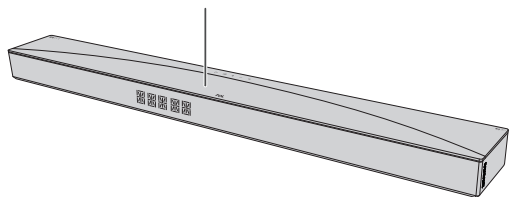

注意：

- **初期化**：サウンドバーのパネル上の **⏻**、**+**、**-**の3つのキーを同時に10秒間長押しして、LEDディスプレイに「初期化」が表示されるまで押し続け、その後電源が自動的に再起動します。



	サウンドバーステータス	LEDディスプレイステータス
電源	電源オン 電源オフ	HELLO STDBY / SLEEP
ソース	HDMI eARC/ARC 光学 USB Bluetooth HDMI入力	HDMI EARC OPT USB BT HDMI IN
Bluetooth	検索モード (点滅) ペアリングモード	BT PAIRING
音量制御	音量 最小音量に達した 最大音量に達した ミュート	V 36 MIN MAX MUTE
オーディオ設定	低音 (+/-) 高音 (+/-) ボイスエンハンス サラウンドエンハンス サラウンドスピーカーVOL (+/-) AI SONIC	BAS LOW / BAS MEDIUM / BAS HIGH TRE LOW / TRE MEDIUM / TRE HIGH VOICE ON / VOICE OFF SURR ON / SURR OFF SURR SPK LOW / SURR SPK MEDIUM / SURR SPK HIGH POSITION 1 / POSITION 2 / POSITION 3 / OFF
サウンドモード	標準/映画/音楽/ ボイス/ゲーム/スポーツ	STANDARD MOVIE MUSIC VOICE GAME SPORTS
ライト	ライト設定	LIGHT 1 / LIGHT 2 / LIGHT 3



사운드바 LED 디스플레이는 다양한 사운드바 기능을 표시합니다.

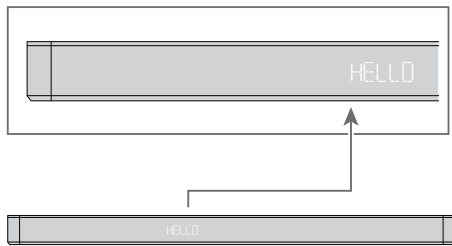

상단의 표시등은 아래 시나리오 상태를 나타냅니다.

1. 전원 켜기: 조명이 중앙에서 측면으로 켜집니다.
2. 전원 끄기: 조명이 측면에서 중앙으로 꺼집니다.
3. Dolby Atmos 포맷: 표시등이 켜집니다.
4. VOL +: 조명이 중앙에서 측면으로 서서히 켜집니다.
5. VOL -: 조명이 측면에서 중앙으로 서서히 꺼집니다.

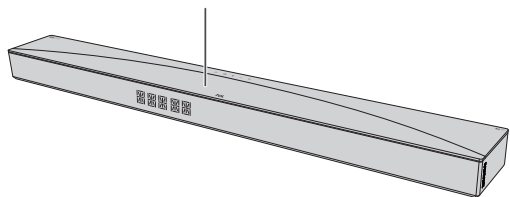

메모:

- 공장 재설정: LED 디스플레이에 "공장 재설정"이 표시될 때까지 바스피커 패널에 있는 세 개의 버튼 (O, + 및 -) 을 동시에 10초 동안 길게 누른 다음 자동으로 전원을 껐다 켭니다.

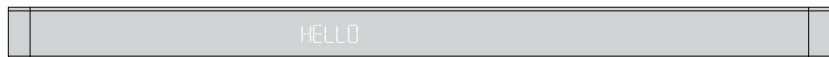

	사운드바 상태	LED 디스플레이 상태
전원	전원 켜기 전원 끄기	HELLO STDBY / SLEEP
소스	HDMI eARC/ARC 옵티컬 USB 블루투스 HDMI IN	HDMI eARC OPT USB BT HDMI IN
블루투스	Searching(검색) 모드(깜박임) Pairing(페어링) 모드	BT PAIRING
볼륨 조절	볼륨 레벨 최소 볼륨 도달 최대 볼륨 도달 음소거	V 36 MIN MAX MUTE
오디오 설정	저음(+/-) 고음(+/-) 음성 향상 서라운드 향상 서라운드 스피커 VOL(+/-)	BAS LOW / BAS MEDIUM / BAS HIGH TRE LOW / TRE MEDIUM / TRE HIGH VOICE ON / VOICE OFF SURR ON / SURR OFF SURR SPK LOW / SURR SPK MEDIUM / SURR SPK HIGH
	AI 소닉	POSITION 1 / POSITION 2 / POSITION 3 / OFF
	패스투 야간	PASS THROUGH / -X- & PASS THROUGH NIGHT ON / NIGHT OFF
사운드 모드	표준/영화/음악/음성/ 게임/스포츠	STANDARD MOVIE MUSIC VOICE GAME SPORTS
조명	조명 설정	LIGHT 1 / LIGHT 2 / LIGHT 3



Soundbar LED顯示螢幕顯示各種Soundbar功能。

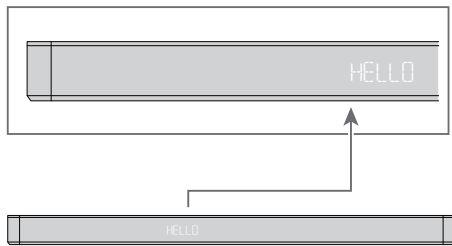

頂部燈將指示下述場景狀態：

1. 電源開啓：燈從中間向兩側亮起。
2. 電源關閉：燈從兩側向中間亮起然後熄滅。
3. Dolby Atmos格式：燈亮起。
4. 音量提高：燈從中間向兩側逐漸亮起。
5. 音量降低：燈從兩側向中間逐漸熄滅。

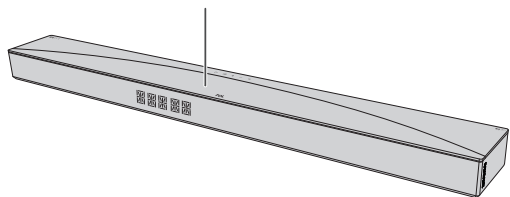

說明：

- 恢復原廠設定：同時長按Soundbar（音量）面板上的 \odot 、+和一三個按鍵10秒，直到LED顯示屏顯示「恢復原廠設定」，然後自動循環開機。



	Soundbar狀態	LED顯示狀態
電源	電源開啓 電源關閉	HELLO STDBY / SLEEP
訊號源	HDMI eARC/ARC 光纖 USB 藍牙 HDMI輸入	HDMI EARC OPT USB BT HDMI IN
藍牙	搜索模式（閃爍） 配對模式	BT PAIRING
音量控制	音量等級 已達到最小音量 已達到最大音量 靜音	V 36 MIN MAX MUTE
音頻設置	低音 (+/-) 高音 (+/-) 語音增強 環繞增強 環繞揚聲器音量 (+/-)	BAS LOW / BAS MEDIUM / BAS HIGH TRE LOW / TRE MEDIUM / TRE HIGH VOICE ON / VOICE OFF SURR ON / SURR OFF SURR SPK LOW / SURR SPK MEDIUM / SURR SPK HIGH
	AI SONIC	POSITION 1 / POSITION 2 / POSITION 3 / OFF
	通過 夜間	PASS THROUGH / -X- & PASS THROUGH NIGHT ON / NIGHT OFF
聲音模式	標準/電影/音樂/語音/ 遊戲/運動	STANDARD MOVIE MUSIC VOICE GAME SPORTS
燈光	燈光設置	LIGHT 1 / LIGHT 2 / LIGHT 3



Màn hình LED của Loa thanh cho biết nhiều loại chức năng của Loa thanh.

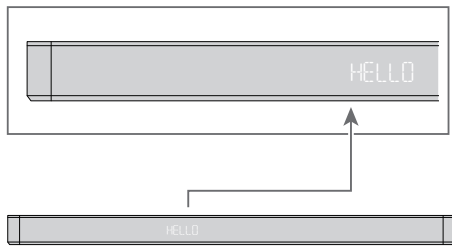

Đèn ở trên cùng sẽ cho biết trạng thái tình huống bên dưới:

1. **Bật nguồn:** Đèn sẽ sáng từ trung tâm sang hai bên.
2. **Tắt nguồn:** Đèn sẽ sáng và tắt từ hai bên đến trung tâm.
3. **Định dạng Dolby Atmos:** Đèn sáng.
4. **Tăng âm lượng:** Đèn sẽ sáng dần từ trung tâm sang hai bên.
5. **Giảm âm lượng:** Đèn sẽ tắt dần từ hai bên về trung tâm.

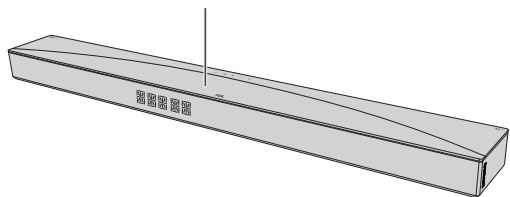

Ghi chú:

- **Khôi phục cài đặt gốc:** Nhấn và giữ ba phím \odot , $+$ và $-$ trên bảng Soundbar trong 10 giây cho đến khi màn hình LED hiển thị "FACTORY RESET" và sau đó tự động bật nguồn.

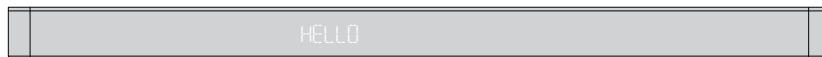

	Trạng thái loa thanh	Trạng thái màn hình LED
Nguồn điện	Bật nguồn Tắt nguồn	HELLO STDBY / SLEEP
Nguồn	HDMI eARC/ARC Quang học USB Bluetooth HDMI IN	HDMI eARC OPT USB BT HDMI IN
Bluetooth	Chế độ tìm kiếm (nhấp nhảy) Chế độ ghép nối	BT PAIRING
Kiểm soát âm lượng	Mức âm lượng Đã đạt âm lượng tối thiểu Đã đạt âm lượng tối đa Im lặng	V 36 MIN MAX MUTE
Cài đặt âm thanh	Tăng/giảm âm trầm Tăng/giảm âm bổng Tăng cường giọng nói Tăng cường âm thanh vòm Tăng/giảm âm lượng Loa vòm AI SONIC Xuyên qua Đêm	BAS LOW / BAS MEDIUM / BAS HIGH TRE LOW / TRE MEDIUM / TRE HIGH VOICE ON / VOICE OFF SURR ON / SURR OFF SURR SPK LOW / SURR SPK MEDIUM / SURR SPK HIGH POSITION 1 / POSITION 2 / POSITION 3 / OFF PASS THROUGH / -X- & PASS THROUGH NIGHT ON / NIGHT OFF
Chế độ âm thanh	Tiêu chuẩn/Phim/Âm nhạc/ Giọng nói/Trò chơi/Thể thao	STANDARD MOVIE MUSIC VOICE GAME SPORTS
Đèn	Cài đặt đèn	LIGHT 1 / LIGHT 2 / LIGHT 3



Tampilan LED Soundbar menunjukkan berbagai fungsi Soundbar.

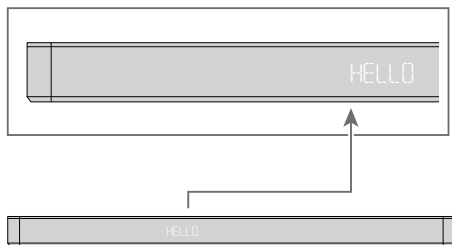

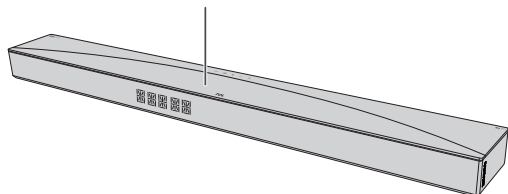

Lampu di atas akan menunjukkan status skenario di bawah ini:

1. Nyalakan: LED akan menyala dari tengah ke samping.
2. Matikan: Lampu menyala dan mati dari samping ke tengah.
3. Format Dolby Atmos: Lampu menyala.
4. VOL +: Lampu akan menyala secara bertahap dari tengah ke samping.
5. VOL -: Lampu akan mati secara bertahap dari samping ke tengah.



Catatan:

- **Reset Setelan Pabrik:** Tekan lama tiga tombol , , dan  pada panel Soundbar secara bersamaan selama 10 detik hingga tampilan LED menunjukkan "RESET SETELAN PABRIK" dan kemudian menyalakan secara otomatis.



	Status Soundbar	Status Tampilan LED
Daya	Nyala Matikan	HELLO STDBY / SLEEP
Sumber	HDMI eARC/ARC Optik USB Bluetooth HDMI IN	HDMI eARC OPT USB BT HDMI IN
Bluetooth	Mode pencarian (berkedip) Mode berpasangan	BT PAIRING
Kontrol volume	Level volume Volume minimum tercapai Volume maksimum tercapai Bisu	V 36 MIN MAX MUTE
Pengaturan audio	Bass (+/-) Treble (+/-) Peningkatan Suara Peningkatan Keliling Speaker Keliling VOL (+/-) AI SONIC Lewati Malam	DPS LOW / DPS MEDIUM / DPS HIGH TRE LOW / TRE MEDIUM / TRE HIGH VOICE ON / VOICE OFF SURR ON / SURR OFF SURR SPK LOW / SURR SPK MEDIUM / SURR SPK HIGH POSITION 1 / POSITION 2 / POSITION 3 / OFF PASS THROUGH / -X- & PASS THROUGH NIGHT ON / NIGHT OFF
Mode suara	Standar/Film/Musik/Suara/Permainan/Olahraga	STANDARD MOVIE MUSIC VOICE GAME SPORTS
Lampu	Pengaturan Lampu	LIGHT 1 / LIGHT 2 / LIGHT 3



จอแสดงผล LED ของ Soundbar แสดงฟังก์ชันต่าง ๆ ของ Soundbar

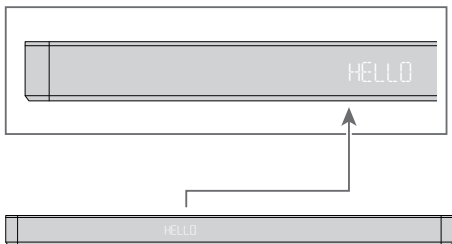

ไฟที่ด้านบนจะแสดงสถานะสถานการณ์ต่อไปนี้:

1. เปิดเครื่อง: ไฟจะเปิดจากตรงกลางไปยังด้านข้าง
2. ปิดเครื่อง: ไฟจะเปิดและปิดจากด้านข้างไปยังตรงกลาง
3. รูปแบบ Dolby Atmos: ไฟเปิดขึ้น
4. VOL +: ไฟจะค่อย ๆ เปิดจากตรงกลางไปยังด้านข้าง
5. VOL -: ไฟจะค่อย ๆ ตบลงจากด้านข้างไปยังตรงกลาง

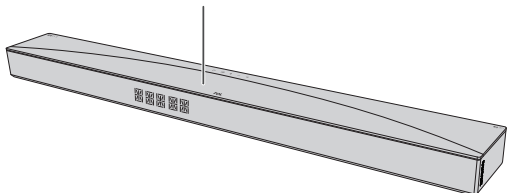

บันทึก:

- รีเซ็ตเป็นค่าจากโรงงาน: กดสามปุ่ม \odot , $+$ และ $-$ บนแผงลำโพงบาร์ค้างไว้พร้อมกันเป็นเวลา 10 วินาทีพร้อมกันจนกระทั่งจอแสดงผล LED แสดง "รีเซ็ตเป็นค่าจากโรงงาน" จากนั้นเปิดปิดเครื่องโดยอัตโนมัติ



	สถานะของ Soundbar	สถานะการแสดงผล LED
พลังงาน	เปิดเครื่อง ปิดเครื่อง	HELLO STBY / SLEEP
แหล่งที่มา	HDMI eARC/ARC Optical USB Bluetooth HDMI IN	HDMI EARC OPT USB BT HDMI IN
Bluetooth	โหมด Searching (การค้นหา) (กะพริบ) โหมด Pairing (การจับคู่)	BT PAIRING
การควบคุมระดับเสียง	ระดับเสียง ถึงระดับเสียงต่ำสุดแล้ว ถึงระดับเสียงสูงสุดแล้ว ปิดเสียง	V 36 MIN MAX MUTE
การตั้งค่าเสียง	เบส (+/-) เสียงแหลม (+/-) การเพิ่มคุณภาพเสียง การปรับปรุงเสียงรอบทิศทาง ลำโพงรอบทิศทาง VOL (+/-) AI SONIC	BAS LOW / BAS MEDIUM / BAS HIGH TRE LOW / TRE MEDIUM / TRE HIGH VOICE ON / VOICE OFF SURR ON / SURR OFF SURR SPK LOW / SURR SPK MEDIUM / SURR SPK HIGH POSITION 1 / POSITION 2 / POSITION 3 / OFF
โหมดเสียง	ผ่านโดยตรง กลางคืน	PASS THROUGH / -X- & PASS THROUGH NIGHT ON / NIGHT OFF
แสงสว่าง	การตั้งค่าแสง	STANDARD MOVIE MUSIC VOICE GAME SPORTS LIGHT 1 / LIGHT 2 / LIGHT 3

4

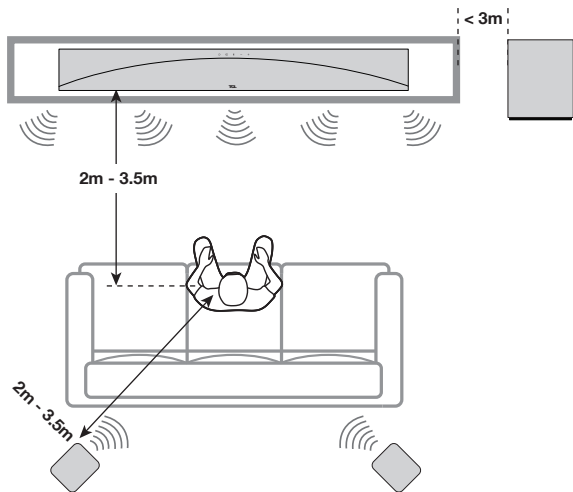

5a



K

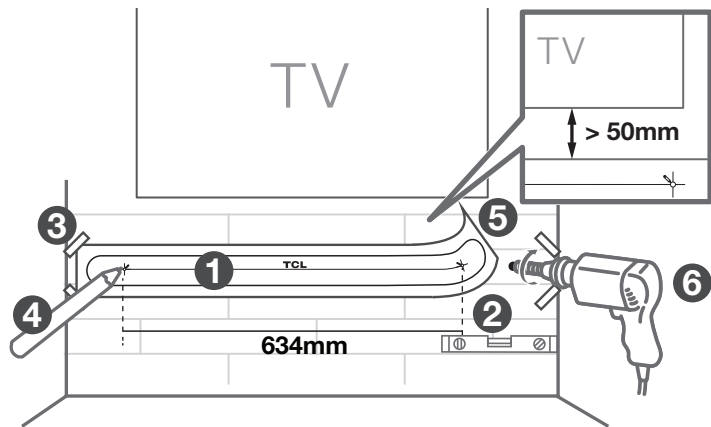
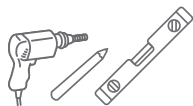
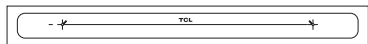

5b

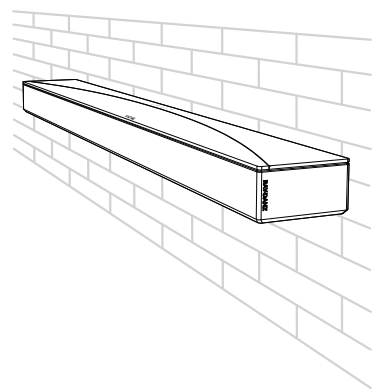
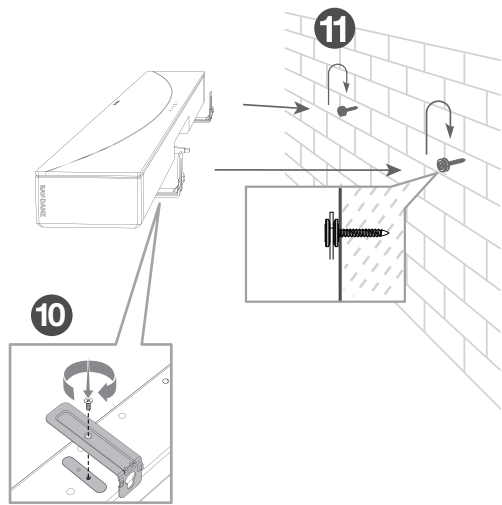
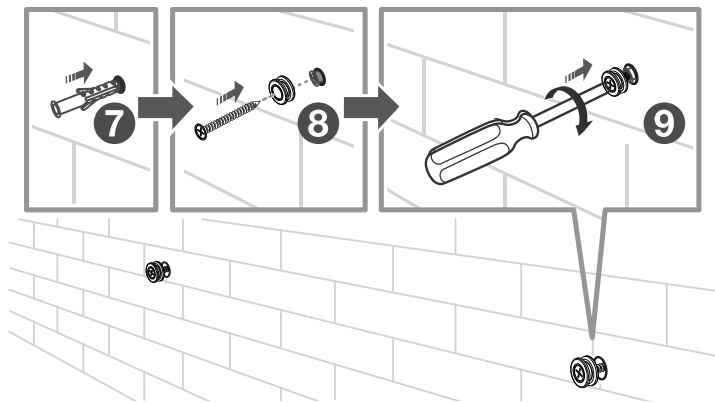
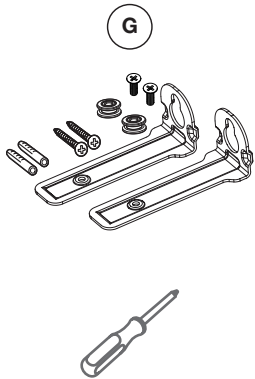



Battery type: 1.5V AAA battery x 2

F

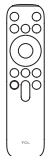

Warning: Do not expose batteries to excessive heat such as sunshine, fire, or the like. Keep new and used batteries away from children. For disposal or recycling information, please contact your local authorities.



CAUTION: Danger of explosion if the battery is incorrectly replaced. Replace only with the same or equivalent type.

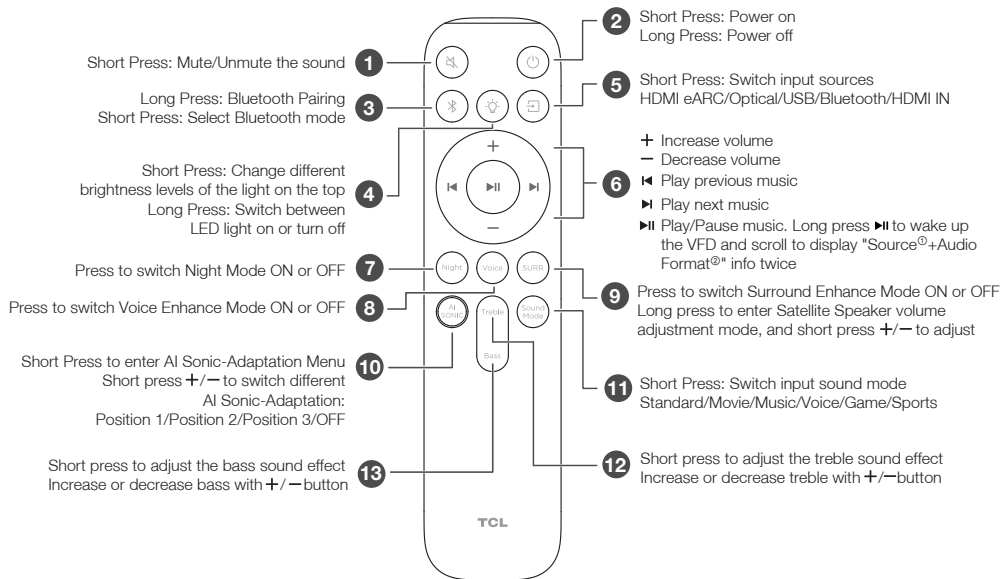
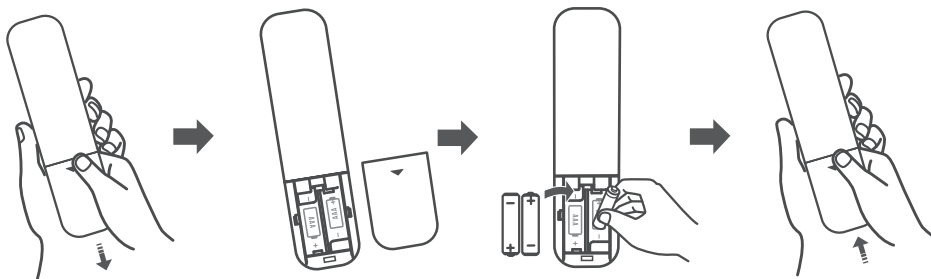

Note:

① Source: HDMI eARC/Optical/USB/Bluetooth/HDMI IN/AirPlay Ready

② Audio Format: PCM AUDIO/DOLBY SURROUND/DOLBY ATMOS/DTS/DTS HD/DTS:X, etc.

6



Type de batterie : Batterie AAA 1,5V x 2

F



! Avertissement : N'exposez pas les batteries à une chaleur excessive, tel que le soleil, le feu, etc. Gardez les batteries neuves et usagées hors de portée des enfants. Pour obtenir des informations sur l'élimination ou le recyclage, veuillez contacter les autorités locales.

! ATTENTION : Risque d'explosion si la batterie n'est pas correctement remplacée. Remplacez uniquement par le même type ou un type équivalent.

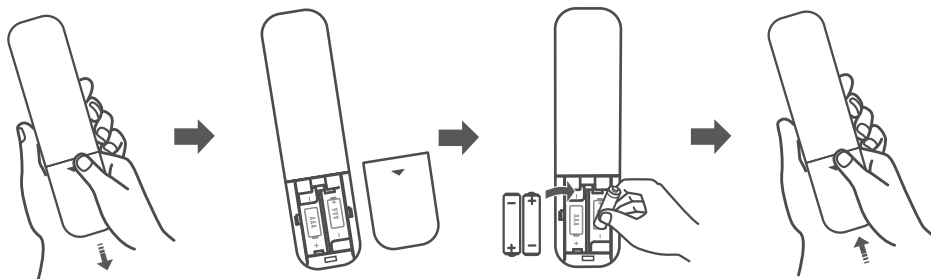

Appui court : Coupe/rétablissement du son **1**

Appui long : Appairage de Bluetooth
Appui court : Sélectionner le mode Bluetooth **3**

Appui court : Modifier les différents niveaux de luminosité du voyant en haut de l'appareil
Appui long : Basculer entre l'allumage et l'extinction du voyant LED **4**

Appuyer sur pour activer ou désactiver le mode Nuit **7**

Appuyer sur pour activer ou désactiver le mode Amélioration Voix **8**

Appuyer brièvement pour passer au menu Adaptation Sonique AI **10**

Appuyer brièvement sur + / - pour passer d'une adaptation sonore AI à l'autre: Position 1/Position 2/Position 3/Arrêt

Appuyer brièvement pour régler l'effet sonore des basses
Augmenter ou diminuer les basses avec le bouton + / - **13**

2 Appui court : Mise sous tension
Appui long : Mise hors tension

5 Appui court : Changer de source d'entrée HDMI eARC/Optique/USB/Bluetooth/ENTRÉE HDMI
+ Augmenter le volume
- Diminuer le volume
◀ Lecture de la musique précédente
6 ▶ Lecture de la musique suivante
⏸ Lecture/Pause de la musique. Appuyez longuement sur ▶ pour réveiller le VFD et faites défiler pour afficher deux fois les informations « Source®+Format Audio® »

9 Appuyer sur pour activer ou désactiver le mode Amélioration Ambiphonie
Appuyez longuement pour entrer dans le mode de réglage du volume de haut-parleur satellite, et appuyez brièvement sur + / - pour le régler

11 Appui court : Changer le mode sonore d'entrée Standard/Film/Musique/Voix/Jeu/Sport

12 Appuyer brièvement pour régler l'effet sonore des aigus
Augmenter ou diminuer les aigus avec le bouton + / -

Remarque :

① Source : HDMI eARC/Optical/USB/Bluetooth/HDMI IN/AirPlay Ready

② Format Audio : PCM AUDIO/DOLBY SURROUND/DOLBY ATMOS/DTS/DTS HD/DTS:X, etc.

6



Tipo de batería: batería AAA de 1,5 V x 2

F



! Advertencia: No exponga las baterías al calor excesivo, como la luz del sol, el fuego o similares. Mantenga las baterías nuevas y usadas fuera del alcance de los niños. Para obtener información de eliminación y reciclaje, comuníquese con las autoridades locales.

! PRECAUCIÓN: Peligro de explosión si la batería se reemplaza incorrectamente. Reemplace sólo con el mismo tipo o equivalente.

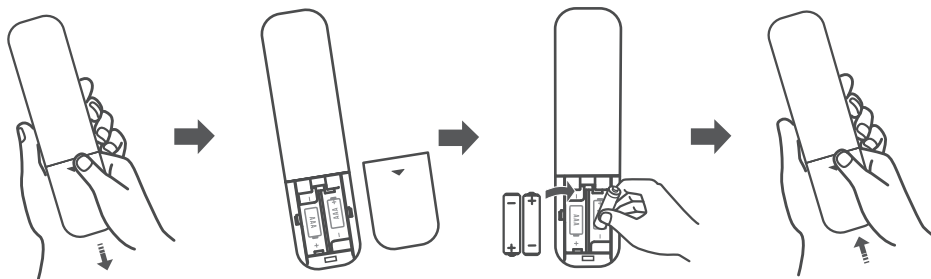

1 Pulsación corta: Silenciar/Activar el sonido
 Pulsación Larga: Emparejamiento de Bluetooth
 Pulsación corta: Seleccionar el modo Bluetooth

2 Pulsación corta: Encendido
 Pulsación larga: Apagado

3 Pulsación corta: Cambiar los diferentes niveles de brillo de la luz en la parte superior.
 Pulsación Larga: Cambiar entre luz LED encendida o apagada

4 Presionar para activar o desactivar el Modo Nocturno

5 Pulsación corta: Cambiar fuentes de entrada HDMI-eARC/Óptica/USB/Bluetooth/HDMI IN
 + Aumentar el volumen
 - Disminuir volumen

6 ◀ Reproducir la música anterior
 ▶ Reproducir la música siguiente
 ▶▶ Reproducir/Pausar la música. Mantenga presionado ▶▶ para activar el VFD y desplácese para mostrar la información "Fuente®+Formato de Audio®" dos veces.

7 Presionar para activar o desactivar el modo de Mejora de Voz.

8 Presionar brevemente para ingresar al menú de Adaptación Sónica de IA
 Presionar brevemente +/− para cambiar diferentes Adaptaciones Sónicas de IA: Posición 1/Posición 2/Posición 3/APAGADO

9 Presionar para activar o desactivar el modo de Mejora de Sonido Envolverte. Mantenga presione para entrar en el modo de ajuste de volumen del altavoz satélite, y presione brevemente +/− para ajustar.

10 Presionar brevemente para ajustar el efecto de sonido grave.
 Aumentar o disminuir los graves con el botón +/−

11 Pulsación corta: Cambiar el modo de sonido de entrada Estándar/Películas/Música/Voz/Juegos/Deportes

12 Presionar brevemente para ajustar el efecto de sonido agudo.
 Aumentar o disminuir los agudos con el botón +/−

13

Nota:

① Fuente: HDMI eARC/Optical/USB/Bluetooth/HDMI IN/AirPlay Ready

② Formato de Audio: PCM AUDIO/DOLBY SURROUND/DOLBY ATMOS/DTS/DTS HD/DTS:X, etc.

6



Tipo de bateria: bateria AAA de 1,5 V x 2

F

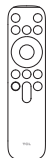

Aviso: Não exponha as baterias a calor excessivo, como a luz solar, o fogo ou similares. Mantenha as baterias novas e usadas longe do alcance de crianças. Para obter informações sobre descarte ou reciclagem, por favor, contacte as autoridades locais.



CUIDADO: Há risco de explosão se a bateria for substituída incorretamente. Substitua somente por uma do mesmo tipo ou do tipo equivalente.

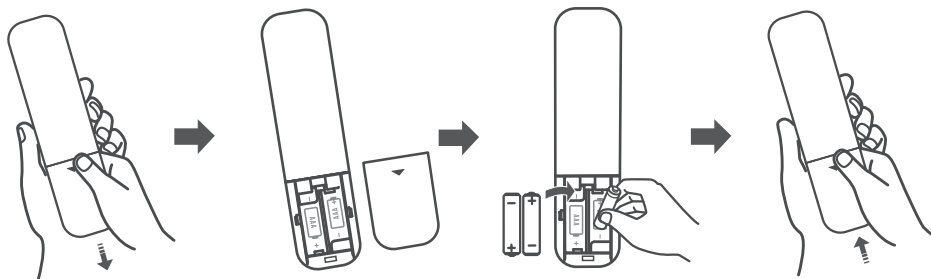

Pressão Breve: Silenciar/Ativar o som **1**

Pressão Longa: Emparelhamento Bluetooth
Pressão Breve: Selecionar o modo Bluetooth **3**

Pressão Breve: Altera os diferentes níveis de brilho da luz na parte superior
Pressão Longa: Alterne entre a luz LED ligada ou desligada **4**

Pressione para ativar ou desativar o Modo Noturno **7**

Pressione para ativar ou desativar o Modo Voice Enhance (Aprimoramento de Voz) **8**

Pressione brevemente para entrar no Menu de Adaptação Sônica AI
Pressione brevemente +/- para alternar entre diferente Adaptação Sônica AI:
Posição 1/Posição 2/Posição 3/DESLIGADA **10**

Pressione brevemente para ajustar o efeito de som grave
Aumentar ou diminuir os graves com o botão +/- **13**

2 Pressão Breve: Ligar
Pressão Longa: Desligar

5 Pressão Breve: Alterne as fontes de entrada HDMI eARC/Ótica/USB/Bluetooth/HDMI IN

+ Aumentar o volume
- Diminuir o volume

6 ◀ Reproduzir a música anterior
▶ Reproduzir a próxima música
▶|| Reproduzir/Pausar música. Pressione longamente ▶|| para ativar o VFD e rolar para exibir as informações "Fonte+Formato de áudio®" duas vezes

9 Pressione para ativar ou desativar o Modo Surround Enhance (Aprimoramento do Surround)
Pressione longamente para entrar no modo de ajuste de volume do alto-falante satélite e pressione rapidamente +/- para ajustar

11 Pressão Breve: Mudar o modo de som de entrada
Padrão/Filme/Música/Voz/Jogo/Esportes

12 Pressione brevemente para ajustar o efeito de som agudo
Aumentar ou diminuir os agudos com o botão +/-

Observação:

① Fonte: HDMI eARC/Optical/USB/Bluetooth/HDMI IN/AirPlay Ready

② Formato de áudio: PCM AUDIO/DOLBY SURROUND/DOLBY ATMOS/DTS/DTS HD/DTS:X, etc.



نوع البطارية: البطارية بنوع AAA بـ1.5 فولت 2X

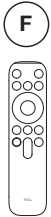

تنبيه: لا تعرض البطاريات للحرارة الزائدة مثل أشعة الشمس أو النار أو ما شابه. احتفظ بالبطاريات الجديدة والمستعملة بعيداً عن متناول الأطفال. للحصول على معلومات حول التخلص أو إعادة التدوير، يرجى الاتصال بالسلطات المحلية.

حذر: يوجد خطر الانفجار إذا تم استبدال البطارية بشكل غير صحيح. استبدال بنفس النوع أو ما يعادلها فقط.

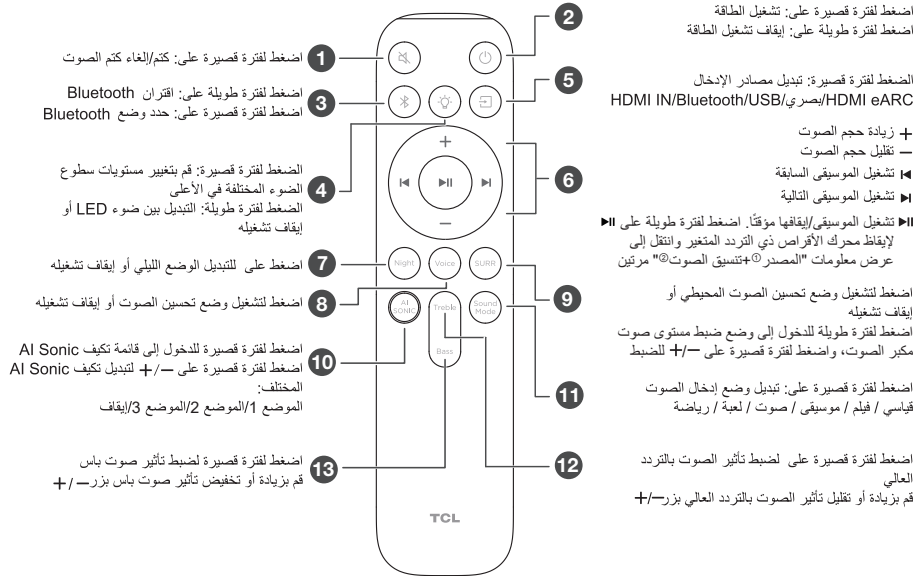
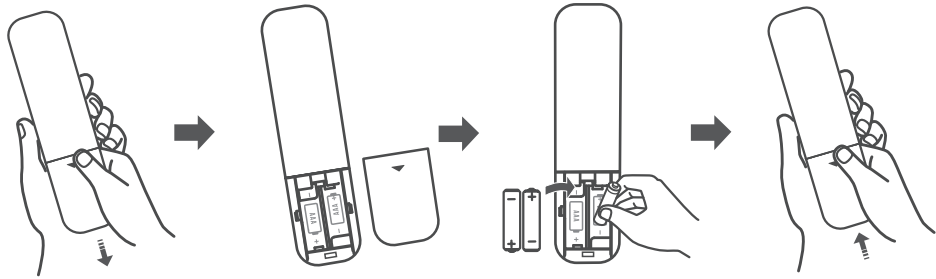

ملاحظة:

① المصدر: HDMI eARC/Optical/USB/Bluetooth/HDMI IN/AirPlay Ready
② تنسيق الصوت: PCM AUDIO/DOLBY SURROUND/DOLBY ATMOS/DTS/DTS HD/DTS:X، إلخ.



電池の種類：1.5V電池 x 2

F

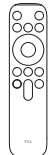

警告：
電池を日光や火気などの過度の熱にさらさないでください。

使用済み・未使用の電池は子どもが届かない場所に保管してください。
廃棄やリサイクルについては、お住まいの地域の自治体にお問い合わせください。



注意事項：爆発の危険があるため、電池を正しい方法に従って交換してください。同一機種または同等品と交換してください。

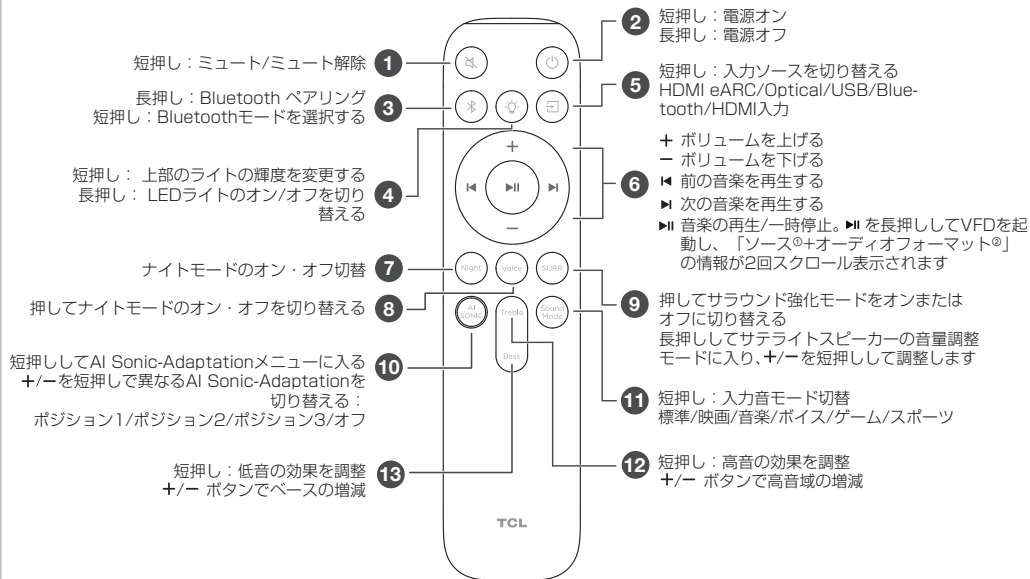
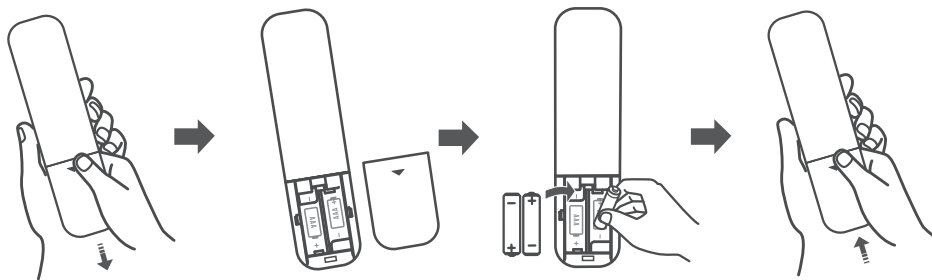

注意：

① ソース：HDMI eARC/Optical/USB/Bluetooth/HDMI IN/AirPlay Ready

② オーディオフォーマット：PCM AUDIO/DOLBY SURROUND/DOLBY ATMOS/DTS/DTS HD/DTS:Xなど。



배터리 유형: 1.5V AAA 배터리 x 2

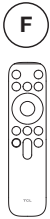

! 경고: 배터리를 햇빛, 불 등과 같은 과도한 열에 노출시키지 마십시오. 새로운 및 사용된 배터리를 어린이에게서 멀리 보관하십시오. 폐기 또는 재활용 정보에 대해 현지 주관부서에 문의하십시오.

! 주의: 배터리를 잘못 교체하면 폭발할 위험이 있습니다. 동일하거나 동등한 유형으로만 교체하십시오.

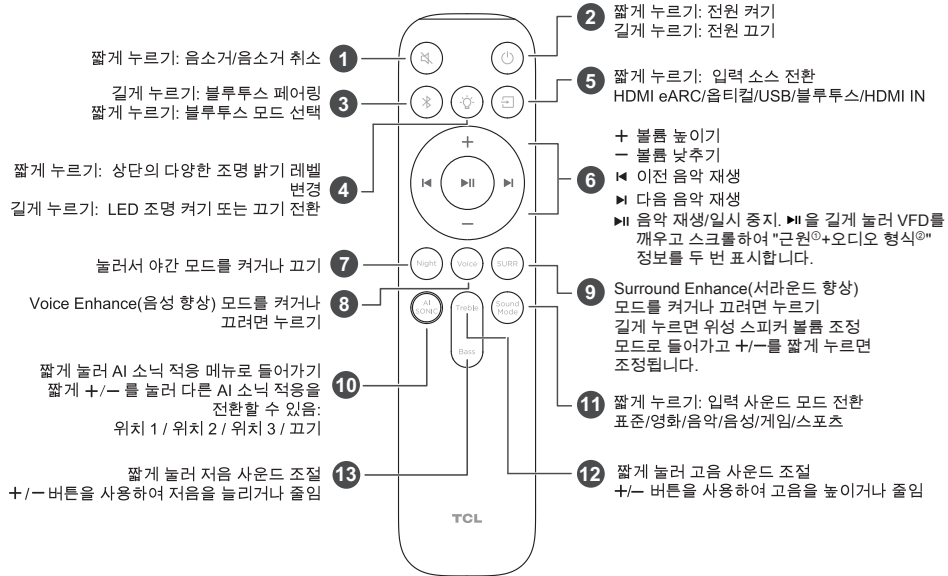
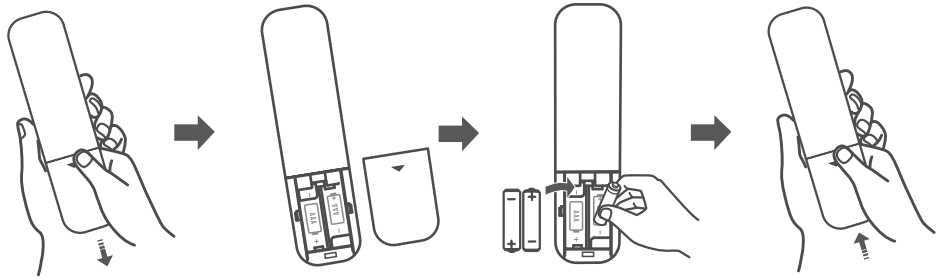

참고:

① 근원: HDMI eARC/Optical/USB/Bluetooth/HDMI IN/AirPlay Ready

② 오디오 형식: PCM AUDIO/DOLBY SURROUND/DOLBY ATMOS/DTS/DTS HD/DTS:X 등



電池類型：1.5V AAA電池×2

F



警告：請勿將電池暴露在過熱環境中，如陽光、火等。請將新的和用過的電池放在兒童接觸不到的地方。有關處置或者回收資訊，請聯繫當地政府。

注意：如果電池更換不當，有爆炸危險。只能使用相同或者等效的型號進行更換。

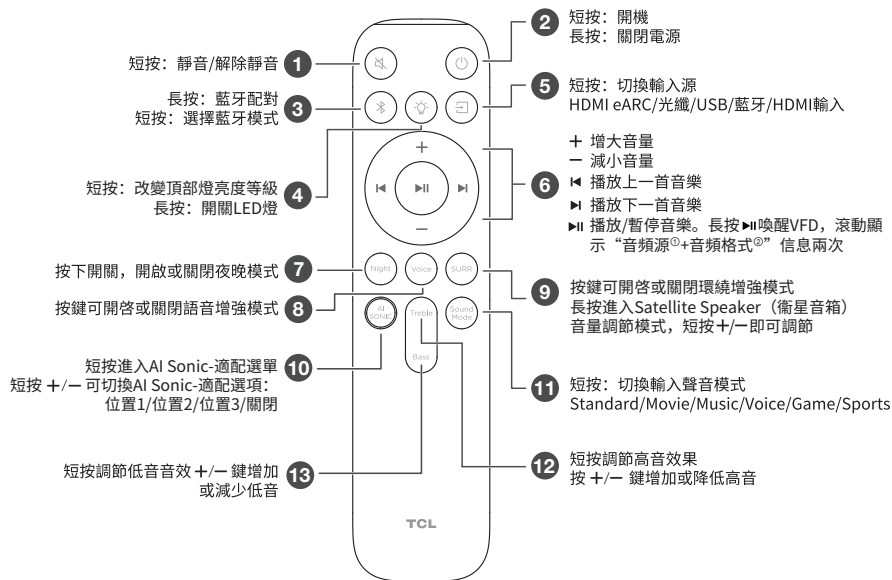
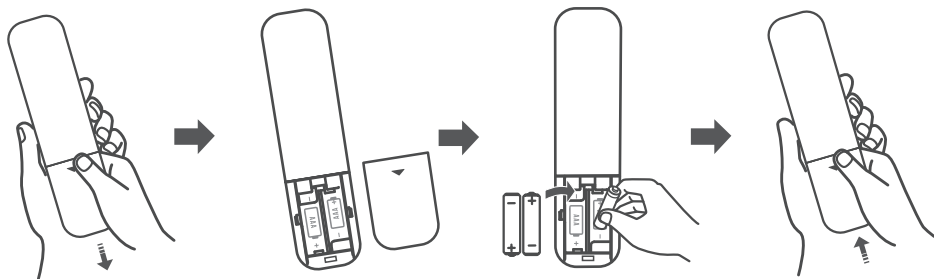

說明：

① 音頻源：HDMI eARC/Optical/USB/Bluetooth/HDMI IN/AirPlay Ready

② 音頻格式：PCM AUDIO/DOLBY SURROUND/DOLBY ATMOS/DTS/DTS HD/DTS:X等

6



Loại pin: Pin AAA 1,5V x 2

F

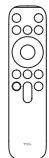

Cảnh báo: Pin không được tiếp xúc với nhiệt độ cao như ánh nắng, lửa hoặc các nguồn nhiệt tương tự. Giữ pin mới và đã sử dụng tránh xa trẻ em. Để biết thông tin về việc loại bỏ hoặc tái chế, vui lòng liên hệ với chính quyền địa phương của bạn.



THẬN TRỌNG: Nguy cơ nổ nếu thay pin không chính xác. Chỉ thay bằng cùng loại hoặc tương đương.

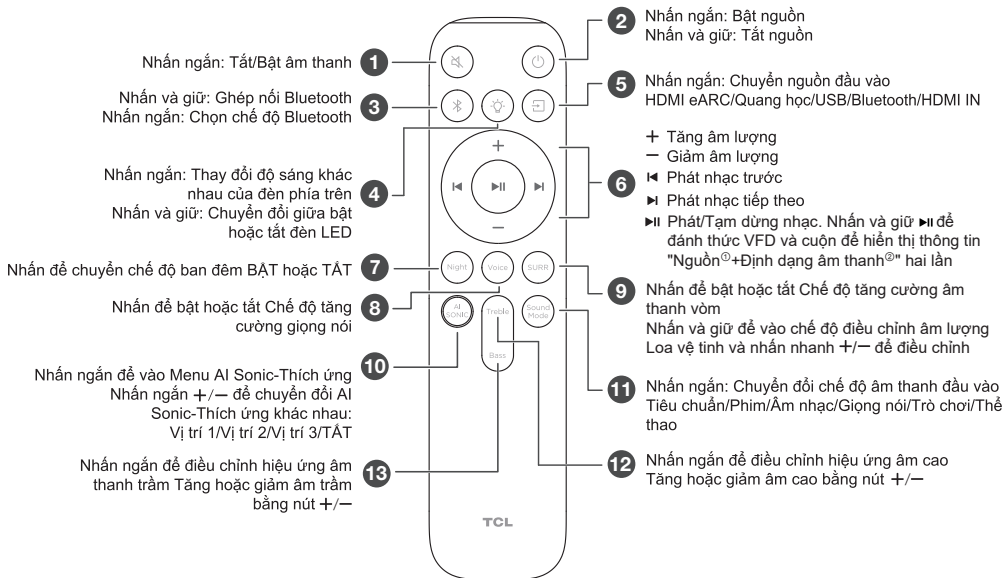
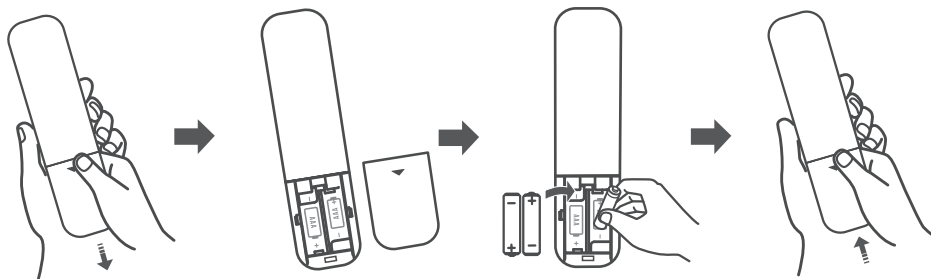

Lưu ý:

① Nguồn: HDMI eARC/Optical/USB/Bluetooth/HDMI IN/AirPlay Ready

② Định dạng âm thanh: PCM AUDIO/DOLBY SURROUND/DOLBY ATMOS/DTS/DTS HD/DTS:X v.v.



Jenis baterai: Baterai AAA 1,5V x 2

F

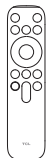

! Peringatan: Jangan biarkan baterai terkena panas yang berlebihan seperti sinar matahari, api, atau sejenisnya. Jauhkan baterai baru dan bekas dari jangkauan anak-anak. Untuk informasi pembuangan atau daur ulang, silakan hubungi pihak berwenang setempat.

! PERHATIAN: Bahaya ledakan jika baterai tidak diganti dengan benar. Ganti hanya dengan tipe yang sama atau setara.

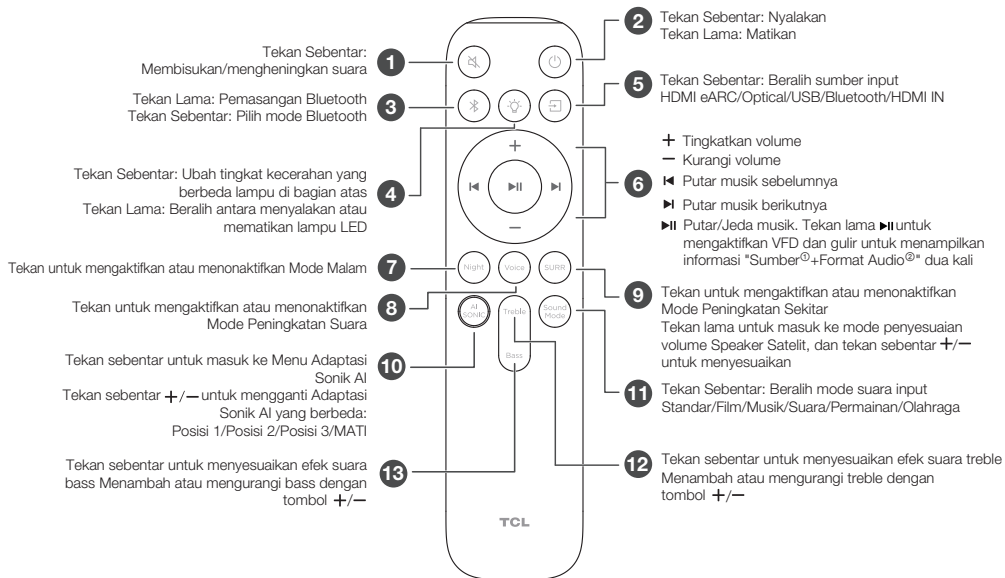
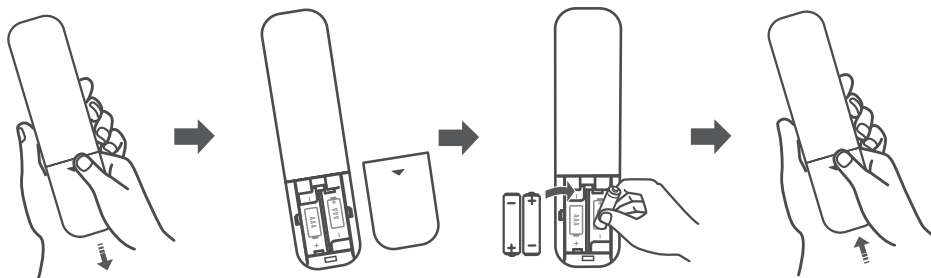

Catatan:

① Sumber: HDMI eARC/Optical/USB/Bluetooth/HDMI IN/AirPlay Ready

② Format Audio: PCM AUDIO/DOLBY SURROUND/DOLBY ATMOS/DTS/DTS HD/DTS:X, dll.

6



ประเภทแบตเตอรี่: แบตเตอรี่ AAA 1.5V x 2

F

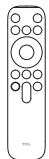

คำเตือน: อย่านำแบตเตอรี่สัมผัสกับความร้อนที่มากเกินไป เช่น แสงแดด ไฟ หรือสิ่งที่คล้ายกัน เก็บแบตเตอรี่ใหม่และใช้แล้วให้ห่างจากเด็ก สำหรับข้อมูลการกำจัดหรือการรีไซเคิลโปรดติดต่อหน่วยงานในพื้นที่ของคุณ



คำเตือน: มีอันตรายที่จะเกิดการระเบิดหากเปลี่ยนแบตเตอรี่ไม่ถูกต้อง แทนที่ด้วยประเภทเดียวกันหรือเทียบเท่าเท่านั้น



NANB

เครื่องวิทยุคมนาคมนี้ ได้รับความคุ้มครองไม่ต้องได้รับใบอนุญาตให้มี ใช้ซึ่งเครื่องวิทยุคมนาคมหรือตั้งสถานีวิทยุคมนาคมตามประกาศ กสทช. เรื่อง เครื่องวิทยุคมนาคม และสถานีวิทยุคมนาคมที่ได้รับยกเว้นไม่ต้องได้รับใบอนุญาตวิทยุคมนาคมตามพระราชบัญญัติวิทยุคมนาคม พ.ศ. 2498



nانب. | โทรคมนาคม

กำกับดูแลเพื่อประชาชน

Call Center 1200 (InswS)

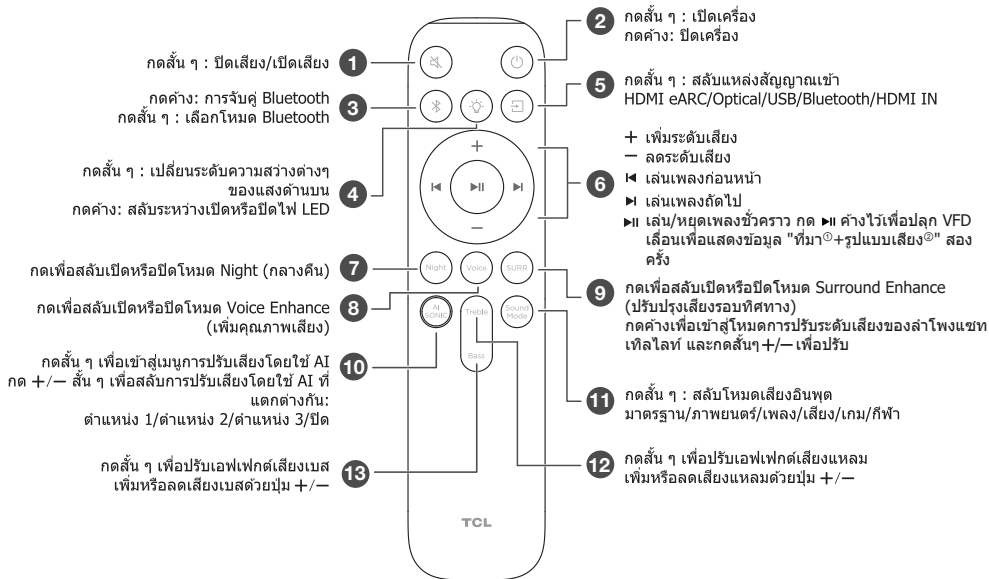
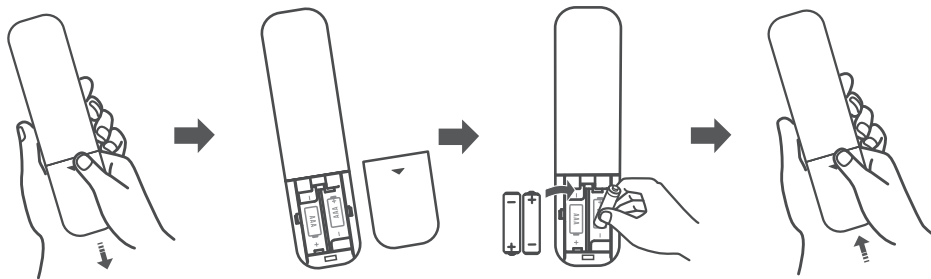

หมายเหตุ:

① ที่มา: HDMI eARC/Optical/USB/Bluetooth/HDMI IN/AirPlay Ready

② รูปแบบเสียง: PCM AUDIO/DOLBY SURROUND/DOLBY ATMOS/DTS/DTS HD/DTS:X เป็นต้น

7a



EN There are 2 ways to connect your soundbar to the TV (listed in order that we recommend): HDMI eARC (refer to 7a) and Optical (refer to 7b).

FR Vous pouvez connecter de 2 manières votre barre de son au téléviseur (elles sont énumérées dans l'ordre que nous recommandons): HDMI-eARC (voir 7a) et Optique (voir 7b).

ES Hay 2 formas de conectar su barra de sonido al televisor (detalladas en el orden en que las recomendamos): HDMI eARC (consulte 7a) y Óptico (consulte 7b).

PT Há 2 formas de conectar seu soundbar à TV (listadas na ordem que recomendamos): HDMI-eARC (consulte o item 7a) e óptica (consulte o item 7b).

AR هناك اثنين طرق لتوصيل مكبر الصوت بالتلفزيون (مذكورة بالترتيب الذي نوصي به): كابل HDMI eARC (ارجع إلى 7a) وكابل ضوئي (ارجع إلى 7b)

JP サウンドバーをテレビに接続する方法は2つあります（推奨順に記載しております）。HDMI eARC（7a参照）、光デジタル（7b参照）

KR 다음 두 가지 방법으로 사운드바를 텔레비전에 연결할 수 있습니다(권장 순서로 나열). HDMI eARC(7a 참조) 및 옵티컬(7b 참조)

CN 有2種方式將條形聲霸連接到電視機（按我們推薦的順序列出）：HDMI eARC（參見7a）和光纖（參見7b）。

VN Có 2 cách để kết nối loa thanh của bạn với TV (được liệt kê theo thứ tự mà chúng tôi đề xuất): HDMI eARC (tham khảo 7a) và Quang học (tham khảo 7b).

ID Ada 2 cara untuk menyambungkan soundbar Anda ke TV (diurutkan sesuai urutan yang kami rekomendasikan): HDMI eARC (lihat 7a) dan Optik (lihat 7b).

TH มี 2 วิธีในการเชื่อมต่อ soundbar ของคุณกับทีวี (แสดงตามลำดับที่เราแนะนำ): HDMI eARC (อ้างอิงถึง 7a) และ Optical (อ้างอิงถึง 7b)

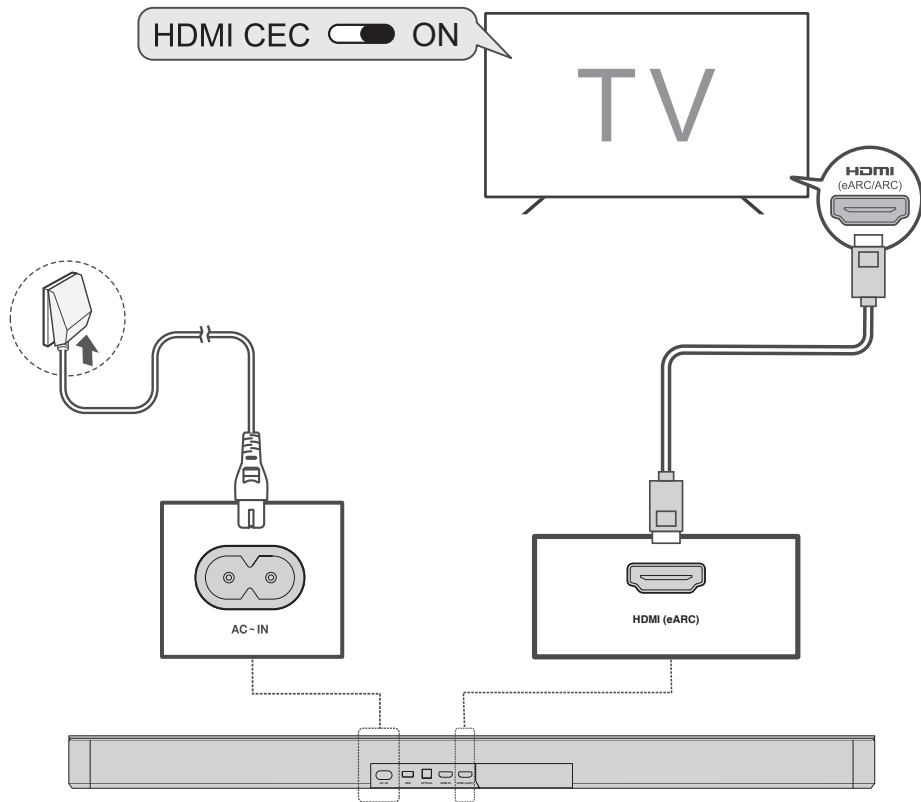

7a



- EN** Connect the soundbar with your TV through a HDMI cable.
- FR** Connectez la barre sonore à votre téléviseur au moyen du câble HDMI.
- ES** Conecte la barra de sonido a su televisor a través del cable HDMI.
- PT** Conecte o soundbar à TV por meio do cabo HDMI.
- AR** قم بتوصيل مكبر الصوت بجهاز التلفزيون من خلال كابل HDMI
- JP** サウンドバーをHDMIケーブルでテレビに接続します。
- KR** HDMI 케이블을 통해 사운드바를 텔레비전과 연결합니다.
- CN** 通過HDMI線將條形聲霸與電視機連接起來。
- VN** Kết nối loa thanh với TV của bạn thông qua cáp HDMI
- ID** Sambungkan soundbar dengan TV Anda melalui kabel HDMI
- TH** เชื่อมต่อ soundbar กับทีวีของคุณผ่านสาย HDMI

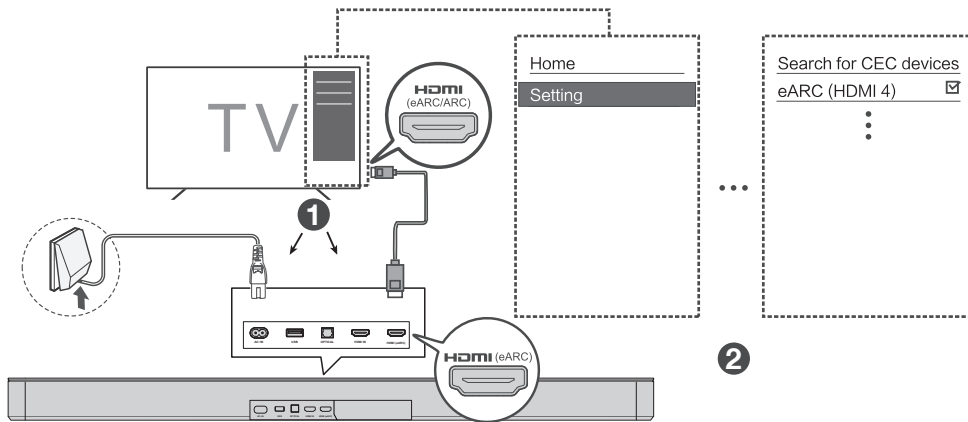
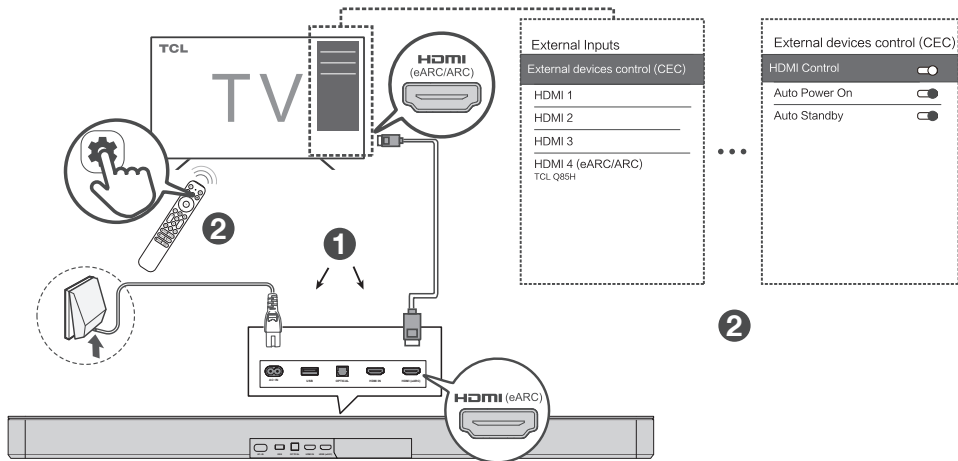



EN Connect the soundbar with your TV through the Optical cable (not supplied).

FR Connectez la barre sonore à votre téléviseur au moyen du câble optique (non fourni).

ES Conecte la barra de sonido a su televisor a través del cable óptico (no suministrado).

PT Conecte o soundbar à TV por meio do cabo óptico (não fornecido).

AR قم بتوصيل مكبر الصوت بجهاز التلفزيون من خلال كابل ضوئي (غير مرفق).

JP 光デジタルケーブル（別売）を介してサウンドバーをテレビに接続します。

KR 광케이블(제공되지 않음)을 통해 사운드바를 텔레비전에 연결합니다.

CN 通過光纜（需自行購買）將條形聲霸與電視機連接。

VN Kết nối loa thanh với TV của bạn thông qua cáp quang (không được cung cấp).

ID Sambungkan soundbar dengan TV Anda melalui kabel Optik (tidak disertakan).

TH เชื่อมต่อ soundbar กับทีวีของคุณผ่านสาย Optical (ไม่ได้นำมา)

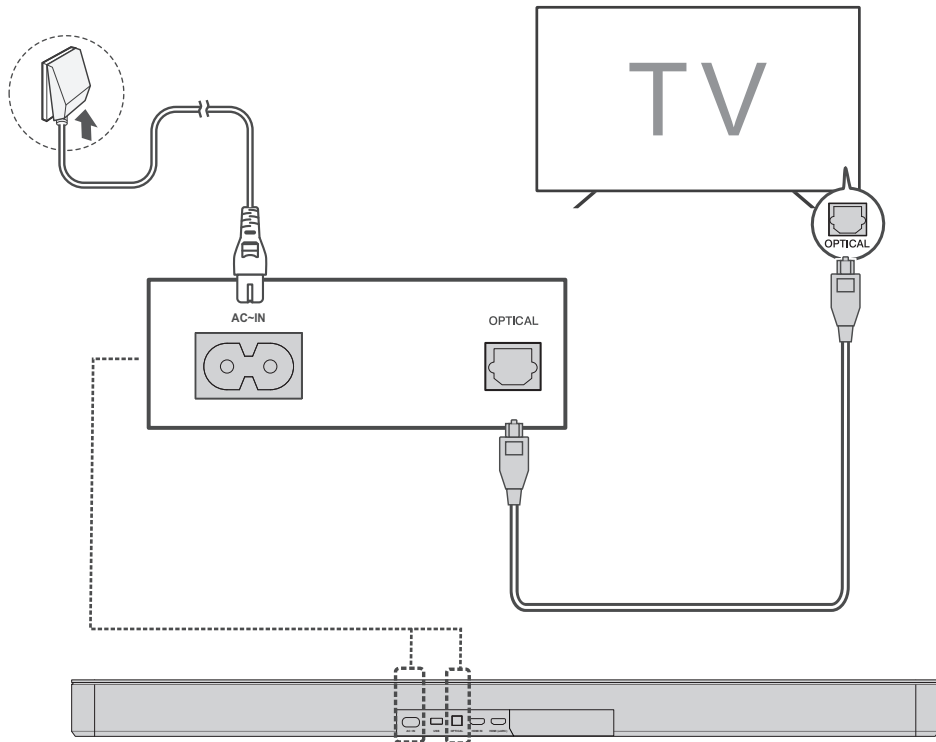



- EN** Select TCL Q85H on your device
- FR** Sélectionnez TCL Q85H sur votre appareil
- ES** Seleccione TCL Q85H en su dispositivo
- PT** Selecione TCL Q85H no seu dispositivo
- AR** حدد TCL Q85H على جهازك
- JP** 接続する機器でTCL Q85Hを選択します
- KR** 장치에서 TCL Q85H를 선택합니다
- CN** 在您的設備上選擇TCL Q85H
- VN** Chọn TCL Q85H trên thiết bị của bạn
- ID** Pilih TCL Q85H pada perangkat Anda
- TH** เลือก TCL Q85H บนอุปกรณ์ของคุณ

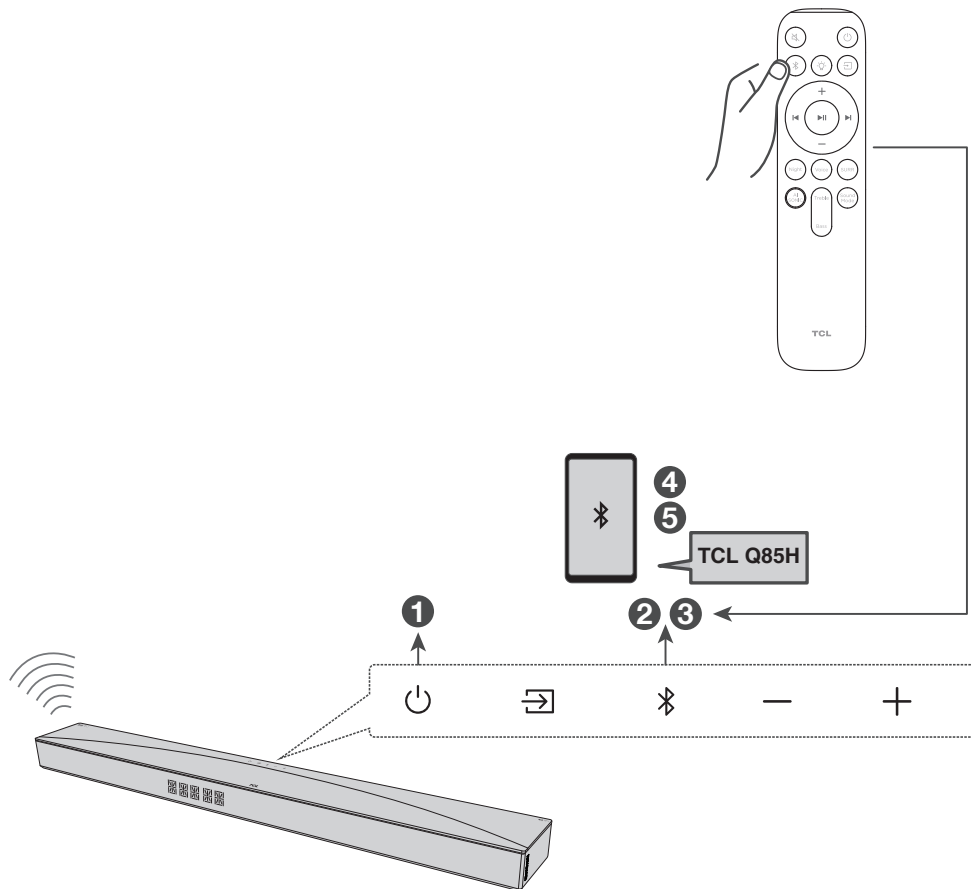

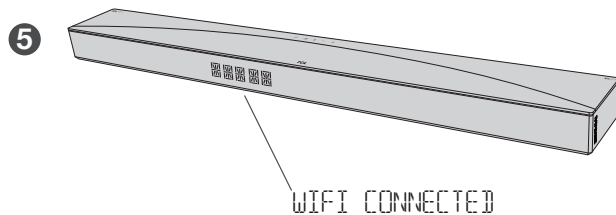
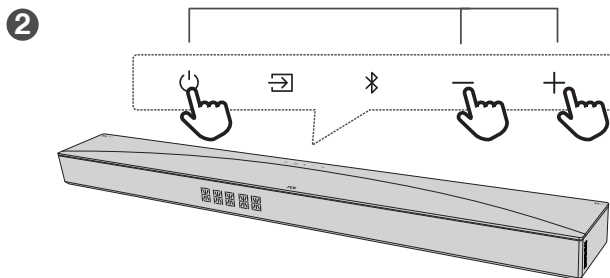
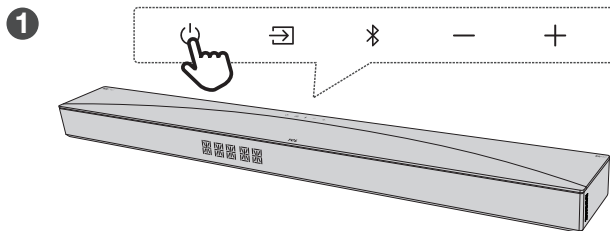



- EN** Supported audio files: MP3, WMA, WAV, FLAC.
USB format: FAT and FAT 32.
- FR** Fichiers audio compatibles : MP3, WMA, WAV, FLAC.
Format USB : FAT et FAT 32.
- ES** Archivos de audio compatibles: MP3, WMA, WAV, FLAC.
Formato USB: FAT y FAT 32.
- PT** Ficheiros de áudio suportados: MP3, WMA, WAV, FLAC.
Formato USB: FAT e FAT 32.
- AR** .MP3· WMA· WAV· FLAC :الملفات الصوتية المدعومة:
.FAT32 و USB: FAT تنسيق
- JP** 対応するオーディオファイル形式 : MP3、WMA、
WAV、FLAC
USBフォーマット : FATとFAT 32
- KR** 지원되는 오디오 파일: MP3, WMA, WAV, FLAC.
USB 포맷: FAT 및 FAT 32.
- CN** 支持音频文件类型: MP3、WMA、WAV、FLAC。
USB格式: FAT和FAT 32。
- VN** Các tệp âm thanh được hỗ trợ: MP3, WMA, WAV, FLAC.
Định dạng USB: FAT và FAT 32.
- ID** File audio yang didukung: MP3, WMA, WAV, FLAC.
Format USB: FAT and FAT 32.
- TH** ไฟล์เสียงที่รองรับ: MP3, WMA, WAV, FLAC
รูปแบบ USB: FAT และ FAT 32

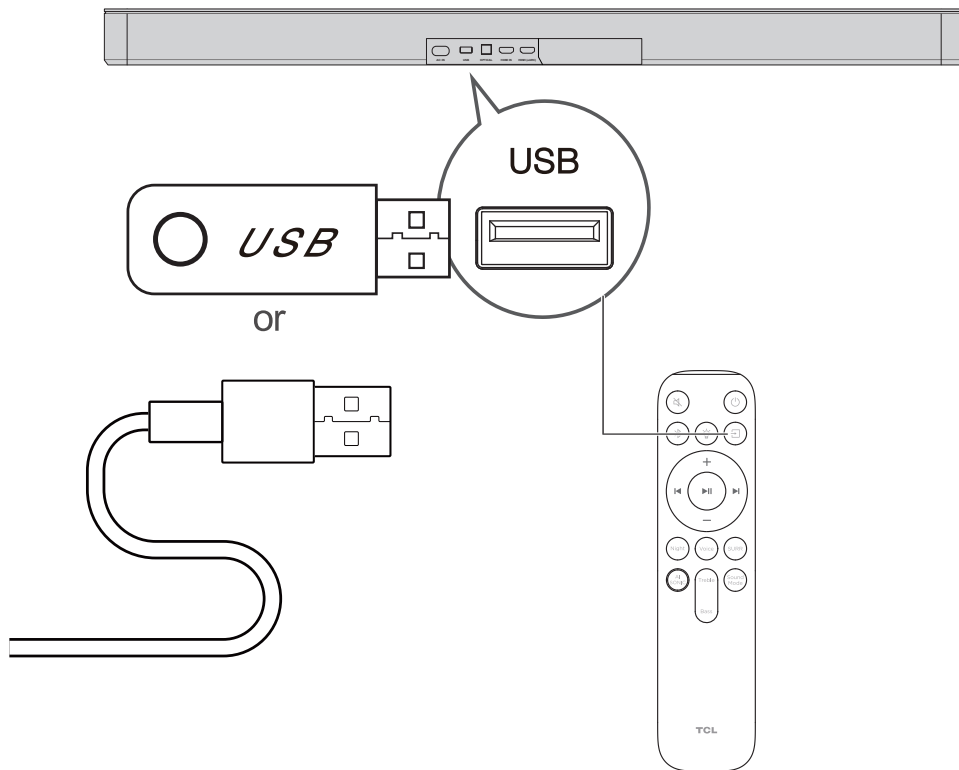



**Settings → Display & Sound → Audio Output →
Internal Speaker+Soundbar(HDMI)**

TCL TV
Ready

- EN** This function is available in some TCL TVs and some TCL models.
FR Cette fonction est disponible sur certains téléviseurs TCL et certains modèles TCL.
ES Esta función está disponible en algunos televisores de TCL y algunos modelos de TCL.
PT Essa função está disponível em algumas TCL TVs e em alguns modelos TCL.
AR .TCL وبعض موديلات TCL وبعض أجهزة تلفزيون TCL وبعض موديلات TCL.
JP この機能は、一部のTCLテレビおよび一部のTCLモデルで利用できます。
KR 이 기능은 일부 TCL 텔레비전 및 일부 TCL 모델에서 사용할 수 있습니다.
CN 部分TCL電視機和TCL機型包含該功能。
VN Chức năng này có sẵn ở một số TV TCL và một số kiểu máy TCL.
ID Fungsi ini tersedia di beberapa TV TCL dan beberapa model TCL.
TH ฟังก์ชันนี้พร้อมใช้ในทีวี TCL บางรุ่นและ TCL บางรุ่น

- EN** The message displayed may differ with the TV model.
FR Le message affiché peut varier en fonction du modèle de téléviseur.
ES El mensaje mostrado puede variar según el modelo de TV.
PT A mensagem exibida pode variar de acordo com o modelo da TV.
AR قد تختلف الرسالة المعروضة باختلاف طراز التلفزيون.
JP 表示されるメッセージは、テレビのモデルによって異なる場合があります。
KR 표시되는 메시지는 텔레비전 모델에 따라 다를 수 있습니다.
CN 顯示信息可能因電視機型號而異。
VN Thông báo hiển thị có thể khác nhau tùy theo kiểu TV.
ID Pesan yang ditampilkan mungkin berbeda tergantung model TV.
TH ข้อความที่แสดงอาจแตกต่างกันไปตามรุ่นทีวี

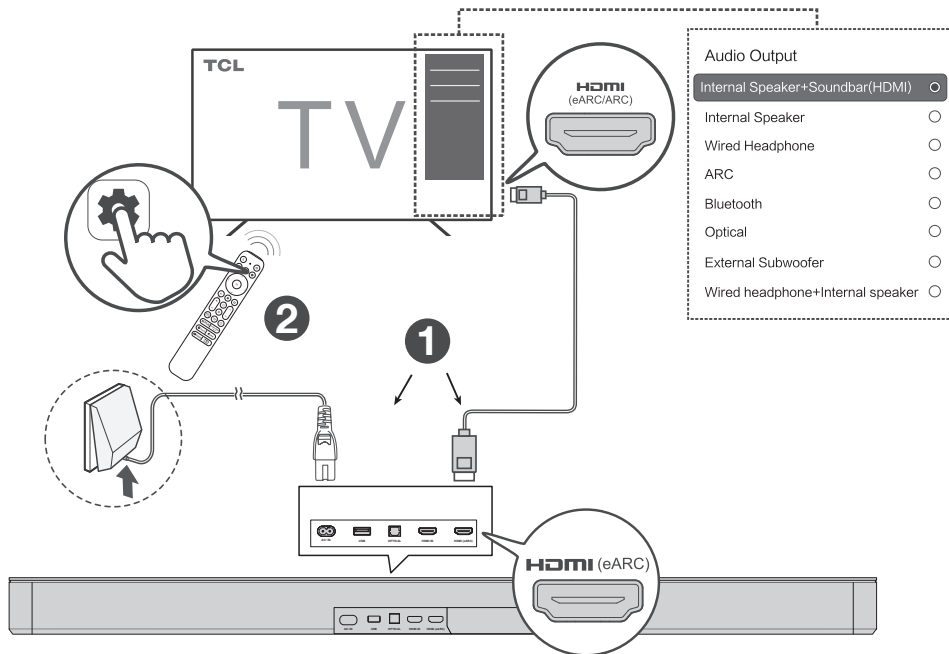

「※本機能は、日本のテレビにはサポートしておりません」

12



TCL
HOME



TCL Home App
Your TCL Smart Hub.
Download Now!

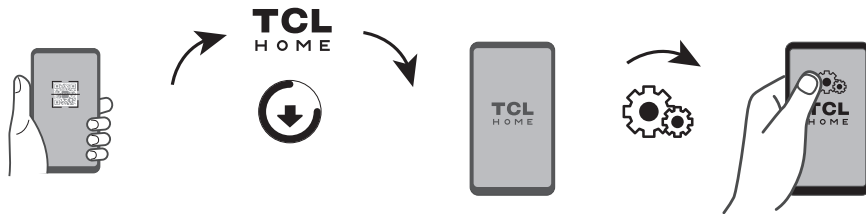

13



AI Sonic-Adaptation

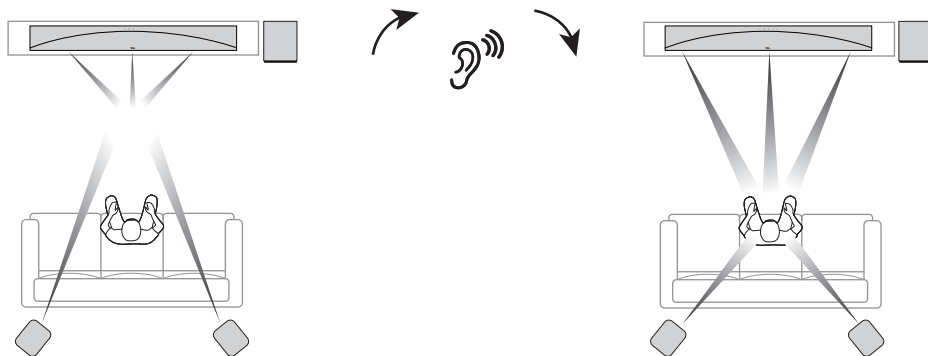

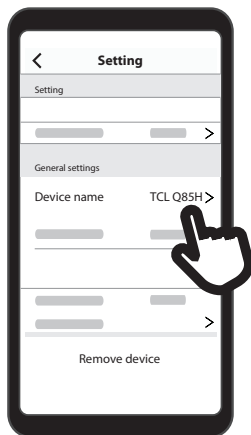

1

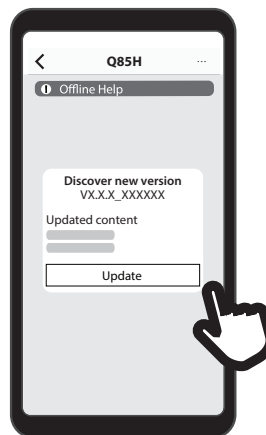

2

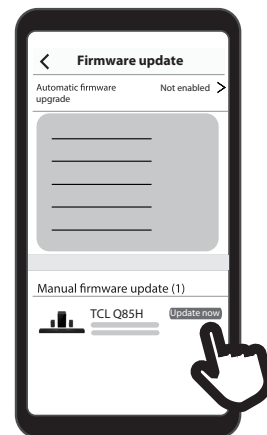

3

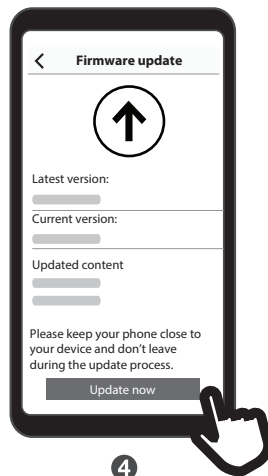

4

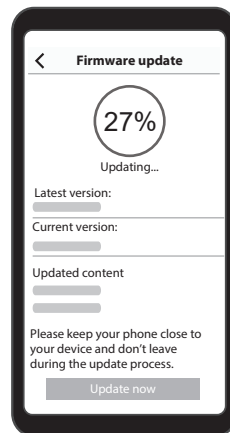

5

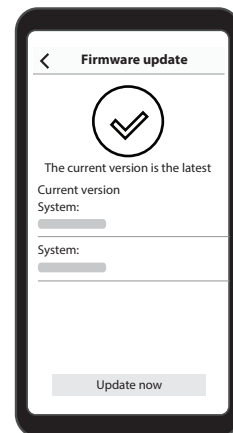

Trademarks



Apple, AirPlay, Apple Home, and Apple TV are trademarks of Apple Inc., registered in the U.S. and other countries and regions.



Dolby, Dolby Atmos, and the double-D symbol are registered trademarks of Dolby Laboratories Licensing Corporation. Manufactured under license from Dolby Laboratories. Confidential unpublished works. Copyright © 2012-2024 Dolby Laboratories. All rights reserved.



The Bluetooth® word mark and logos are registered trademarks owned by Bluetooth SIG, Inc. and any use of such marks by TTE Corporation is under license. Other trademarks and trade names are those of their respective owners.



For DTS patents, see <http://xperi.com/dts-patents/>. Manufactured under license from DTS Licensing Limited. DTS, DTS:X, and the DTS:X logo are registered trademarks or trademarks of DTS, Inc. in the United States and other countries. © 2024 DTS, Inc. ALL RIGHTS RESERVED.



"The terms HDMI, HDMI High-Definition Multimedia Interface, HDMI trade dress and the HDMI Logos are trademarks or registered trademarks of HDMI Licensing Administrator, Inc."



The Wi-Fi CERTIFIED Logo is a trademark of Wi-Fi Alliance®.

DO NOT RETURN TO STORE

**WE ARE
READY TO
HELP** contact us first
with any questions



TCL SUPPORT:
www.tcl.com



**TAKE CARE WHEN
REMOVING THE SOUND BAR**